

## SSIAM Series Wired Round Clock (V4.3)

### Features:

- Available in 9" (22.8cm), 12" (30.4 cm), and 16" (40.6 cm) dial sizes
- Offered in a low-profile metal case or SlimLine ABS case
  - Optional Cherry Wood finish or Brushed Aluminium finish
- Multiple power options
  - Offered in 230VAC and 24VAC/VDC models
- Provided with mounting hardware for easy installation
- Hour, minute, and second hands
- Quick correction for time change (max. 5 minutes when used with digital communication protocol)
- Microprocessor based movement
- Side molded, polycarbonate crystal

### Highlights:

- Automatically recognizes many wired time data protocols:
  - 2-wire digital communication system (24V clock only)
  - 3-wire digital communication system
  - Sync-wire 59 minute correction
  - Various Sync-wire 58 minute correction formats
  - National Time/Rauland correction
- Correctly interprets time data protocols even if the **signal** wire polarity is switched.
- Built-in self-diagnostic mode:
  - Communication Protocol Verification
  - Time since the last synchronization signal was received
  - Hand position error detection
- Custom Color Cases available (minimum quantity 25)
- Designed and Produced in the United States of America

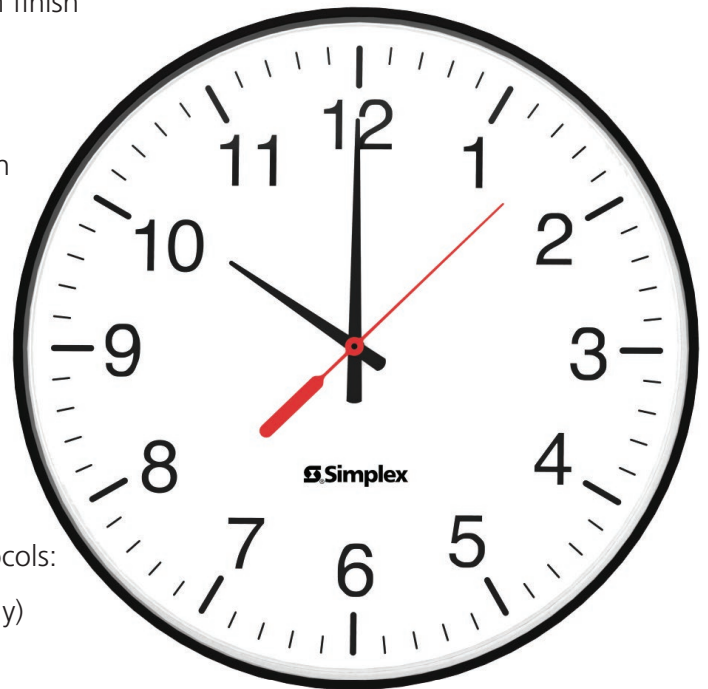

## SSIAM Series Wired Round Clock (V4.3)

### Specifications:

#### Case Material:

Steel or ABS.  
Cherry wood finish or brushed aluminum finish for the SlimLine ABS case are also available.

#### Case Color:

Standard black finish (custom colors available)

#### Dial Face:

12 or 24 (military) hour standard  
Specialty dials available

#### Dial Material:

Durable polystyrene

#### Crystal Material:

Shatter-proof, side-molded, transparent polycarbonate

#### Voltage Input:

7 - 28 VDC/VAC 50/60 Hz (24V model)

180 - 260 VAC 50/60 Hz (230V model)

#### Average Current Consumption:

35 mA @ 24VDC/VAC

15 mA @ 230VAC

#### Hand tolerance:

Minute hand: +/- 1/4 minute

Second hand: +/- 1/2 second

#### Temperature range:

Operating: 32°F - 113°F (0°C - 45°C)

Shelf: 5°F - 167°F (-15°C - 75°C)

#### Compliance:

UL, cUL listed, CE Compliances: EMC, LVD



### Ordering Information:

SSIAM Series Wired Round Clock: SSIAM-XXS-XXR-X-XX

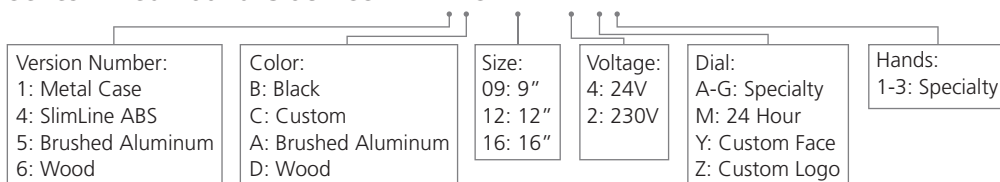

Double Mount Housing: SSAX-4XD-XXR-0

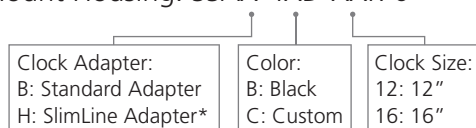

**Note:** Purchasing double mounted round analog clocks will require two clocks using the clock part number and one double mount housing using the part number above.

\*Note: SlimLine and Aluminum clocks use the SlimLine Adapter.

#### Examples:

SSIAM-6DS-09R-4: Simplex Analog, Wired SSIAM, 9" Round, 24V, Surface Wall Mount, Solid Cherry Wood Frame, Supports: 2-Wire Digital & Sync Wire Protocols

SSIAM-5AS-12R-2: Simplex Analog, Wired SlimLine SSIAM, 12" Round, 230 VAC, Surface Wall Mount, Brushed Aluminum Case, Supports: Sync Wire Protocols

# SSIAM Series Wired Round Clock (V4.3)

## Simplex Round Analog Clock Dimensions

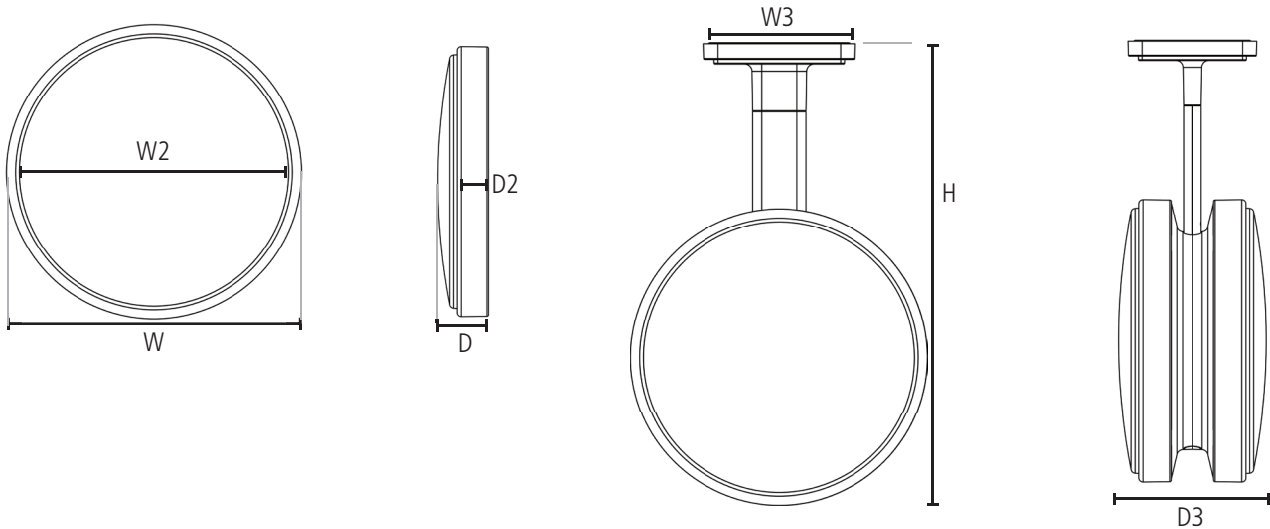

### METAL

### SLIMLINE ABS

Clock Size:	12" Standard	16" Standard	9" SlimLine	12" SlimLine	16" SlimLine
W	12.75" (32.4cm)	16.75" (42.6cm)	9.8" (24.8cm)	12.9" (32.7cm)	16.7" (42.3cm)
W2	11.80" (30.0cm)	15.75" (40.0cm)	9.5" (24.2cm)	12.6" (32.0cm)	16.3" (41.5cm)
D	2.44" (6.2cm)	2.50" (6.4cm)	2.4" (6.2cm)	2.4" (6.2cm)	2.5" (6.4cm)
D2	1.45" (3.7cm)	1.60" (4.1cm)	1.7" (4.2cm)	1.7" (4.3cm)	1.7" (4.4cm)
Shipping Weight:	4.0lbs (1.81kg)	6.0lbs (2.72kg)	2 lbs (0.9 kg)	2 lbs (0.9 kg)	4 lbs (1.8 kg)
Double/Dual Mount Dimensions:	W3 = 6.56" (16.7cm) D3 = 6.86" (17.5cm)	W3 = 6.56" (16.7cm) D3 = 8.00" (20.3cm)	Not Applicable	W3 = 6.6" (16.7cm) D3 = 6.4" (16.2cm)	W3 = 6.6" (16.7cm) D3 = 6.4" (16.3cm)
Adjustable Pole Height:	H = 19.69" (50.0cm) = 18.07" (45.9cm) = 16.45" (41.8cm)	H = 21.90" (55.6cm) = 20.20" (51.3cm) = 18.56" (47.1cm)	Not Applicable	H = 19.7" (50.2cm) = 18.1" (46.1cm) = 16.5" (41.9cm)	H = 21.7" (55.3cm) = 20.1" (51.2cm) = 18.5" (47.0cm)

### ALUMINUM

### WOODEN

Clock Size:	9" Aluminum	12" Aluminum	16" Aluminum	9" Wood	12" Wood	16" Wood
W	10.7" (27.1cm)	13.8" (35.0cm)	17.8" (45.1cm)	11.6" (29.5cm)	13.3" (33.8cm)	19.6" (49.9cm)
W2	9.5" (24.2cm)	12.6" (32.0cm)	16.3" (41.5cm)	9.5" (24.2cm)	12.6" (32.0cm)	16.5" (41.5cm)
D	2.4" (6.2cm)	2.4" (6.2cm)	2.4" (6.4cm)	D* = 2.4" (6.2cm)	D* = 2.4" (6.2cm)	D* = 2.4" (6.4cm)
D2	1.7" (4.2cm)	1.7" (4.4cm)	1.7" (4.4cm)	D2* = 2.7" (6.8cm)	D2* = 2.7" (6.8cm)	D2* = 2.7" (6.8cm)
Shipping Weight:	2 lbs (0.9kg)	3 lbs (1.4 kg)	4 lbs (1.8 kg)	3 lbs (kg)	4 lbs (1.8 kg)	6 lbs (2.7 kg)
Double/Dual Mount Dimensions:	Not Applicable	W3 = 6.6" (16.7cm) D3 = 6.4" (16.2cm)	W3 = 6.6" (16.7cm) D3 = 6.4" (16.3cm)	Not Applicable	Not Applicable	Not Applicable
Adjustable Pole Height:	Not Applicable	H = 20.2" (51.5cm) = 18.6" (47.3cm) = 17.0" (43.2cm)	H = 22.3" (56.6cm) = 20.6" (52.4cm) = 19.0" (48.2cm)	Not Applicable	Not Applicable	Not Applicable

\*NOTE: For wood clocks, the rim (D2) protrudes further from the wall than the crystal (D).

# SSIAM Series Wired Round Clock (V4.3)

## Hand & Dial Options



Standard Hands



Specialty Hands 1

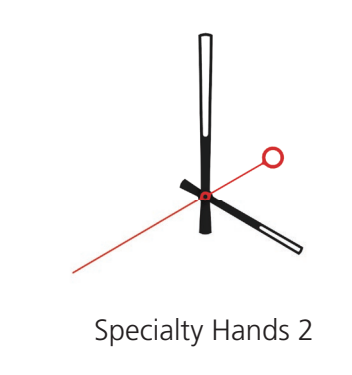

Specialty Hands 2

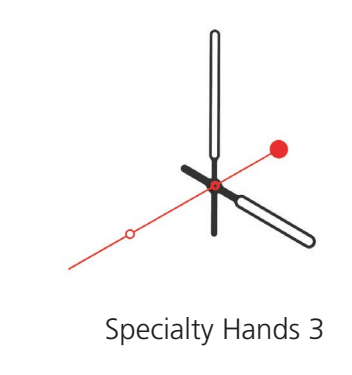

Specialty Hands 3

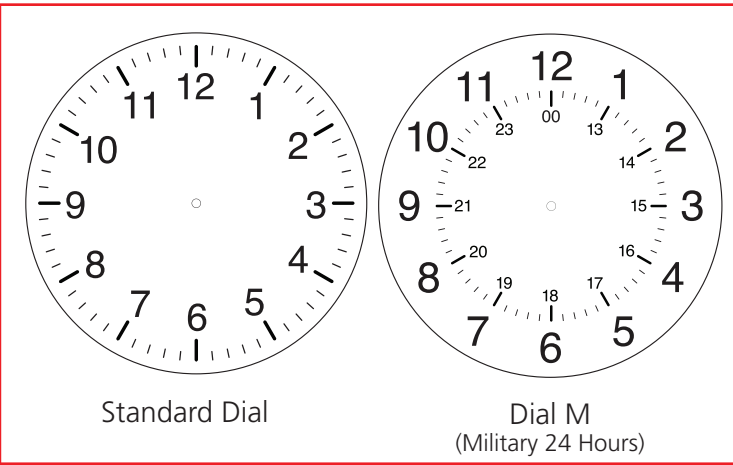

Standard Dial

Dial M  
(Military 24 Hours)

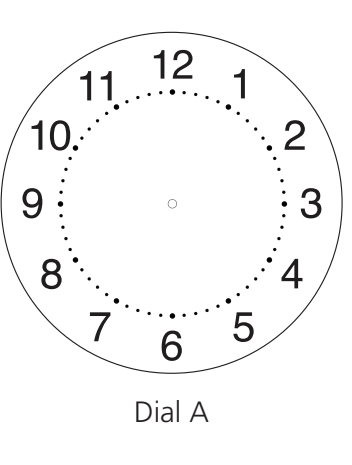

Dial A

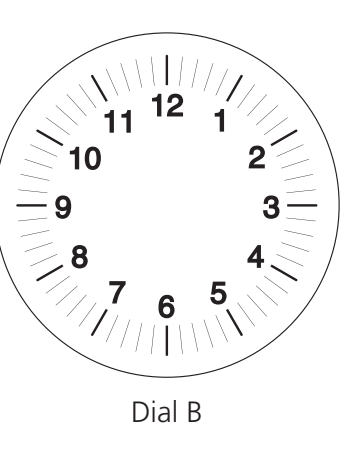

Dial B

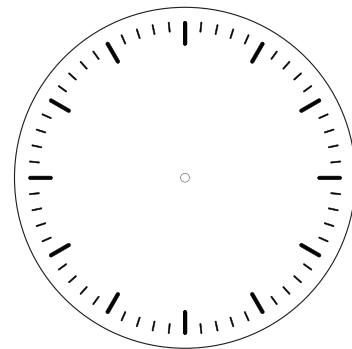

Dial C

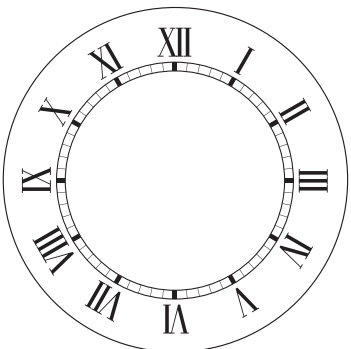

Dial E

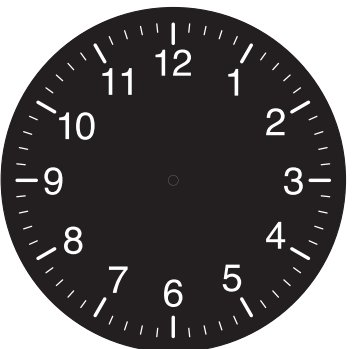

Dial F

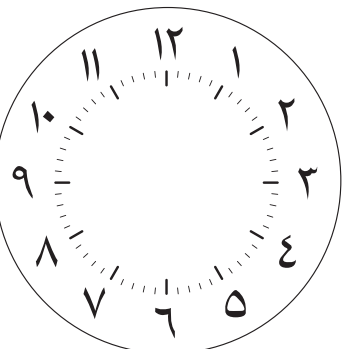

Dial G

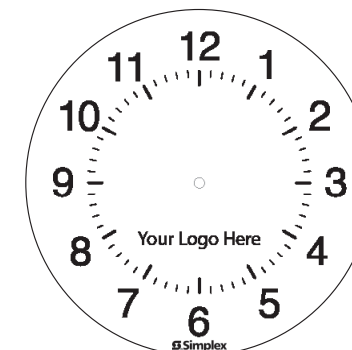

Dial Z

Specialty Hands 1-3 & Specialty Dials A-Z are offered at an additional cost.

For more information please contact your Simplex Representative.

**SSIAM Series Wired Round Clock (V4.3)**

**Clock Case Options**



Standard Low Profile  
Metal Case



Standard SlimLine  
ABS Case



Brushed Aluminum Finish



Solid Wood Case Cherry Finish

