

DESCRIPTION







- Analogue display clock.
- Hour-Minute or Hour-Minute-Second display.
- Water-resistant ABS casing - IK02, IP 55.
- Optimal viewing distance: 35m
- Polymethacrylate protective glass.
- Dial models: arabic figures or minute notches.
- Black wall bracket in glass fibre reinforced polycarbonate.
- Mains operated or slave clock delivered pre-wired with a 5-m cable.



STANDARDS

- Standard EN 50081-1: Generic Emissions.
- Standard EN 50082-1 and 50082-2: Generic Immunity.
- Standard EN 55022 class B: Information Technology Equipment- Radio disturbance characteristics.
- Standard EN 60950: Information Technology Equipment - Safety.
- Radio Standard EN 300-220-3 and EMC Standard EN 301-489-3 for Radio Equipment.
- Standard AFNOR NFS 87-500 C.

TECHNICAL FEATURES

| | Movement | Power supply | Operating temperatures | Weight |
|---|----------------------|-----------------------|------------------------|--------|
| | Quartz 1.5 V | 1.5V LR6 battery | - 5°C to +50°C | 2.1 kg |
| | 230V quartz | 230 Volts* | - 20°C to +50°C | 2.1 kg |
|  | 24V minute rec. | | - 20°C to +50°C | 2.3 kg |
|  | 24V ½ minute rec. | | - 20°C to +50°C | 2.3 kg |
|  | ½ minute series rec. | | - 20°C to +50°C | 2.3 kg |
|  | AFNOR TBT rec. | 6 to 24 VDC | - 20°C to +50°C | 2.3 kg |
|  | DCF Radio | 1.5V LR6 battery | - 5°C to +55°C | 2.1 kg |
|  | Radio DHF rec. | 2x 1.5V LR6 batteries | - 5°C to +50°C | 2.1 kg |
|  | Radio DHF 230V rec. | 230V | - 20°C to +50°C | 2.1 kg |

*230V AC power supply only via a time setting control box (ref: 933006).

REFERENCES

Hour-Minute

- 984 11*1A** Independent battery quartz clock
- 984 211A** 230V Quartz clock HM
- 984 311A** DCF radio
- 984 511A** 24V minute impulse clock
- 984 611A** ½ minute serial receiver
- 984 711A** 24V ½ minute receiver
- 984 811A** AFNOR TBT receiver
- 984 B11A** DHF battery slave clock
- 984 C11A** DHF 230V slave clock
- 984 F1*1A** NTP receiver

1 = «Arabic figures»



2 = «Minute notches»



* The next to last figure of the reference number represents the type of dial:
1 = figures, 2 = notches.



MOVEMENTS AND SYNCHRONISATION

- **Battery quartz autonomous movement with second hand**

The clock is completely autonomous, the time information is provided by its own time system.

- **DCF radio controlled movement**

The DCF radio controlled movement provides high accuracy and automatic summer/winter changeovers.

- **IRIG-B/AFNOR coded time receiver**

The coded time distribution consists in transmitting a complete time message every second: the time on the receiver is automatically and immediately set after connection to the clock line.

The IRIG-B/AFNOR coded time does not transmit interference and is insensitive to other electrical interference.

- **24V minute impulse slave movement**

Slave clocks are connected to a distribution line and activated through electrical impulses sent every minute by the master clock.

- **1/2 minute serial impulse slave movement**

Slave clocks are connected to a distribution line and activated through electrical impulses sent every ½ minute by the master clock.

- **1.5V serial impulse slave movement (for BT radio)**

Slave clocks are connected to a radio synchronisation box (BT radio) that generates electrical impulses every minute.

- **DHF receiver**

The DHF clocks pick up the radio signal and get automatically synchronised. If radio reception is poor, they keep on working on their own time basis.

Clocks with AFNOR or DHF movement have hand position control and automatic time setting.



MOUNTING ACCESSORIES

- **938 914**..... 230V power supply with screw terminal for TBT clock
- **938 916**..... 230V power supply with mains plug for TBT clock

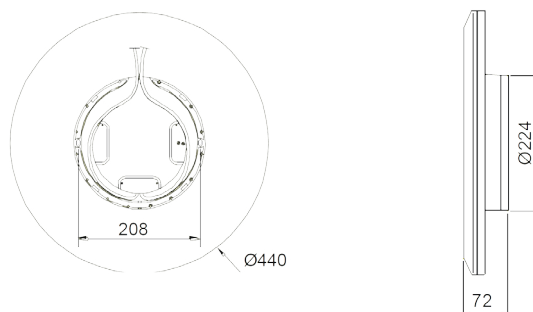

Dimensions in mm

Réf.: 643031E 04/17

