

SSIAP Series IP Round Clock (V1.0)

Features:

- Available in 9" (22.8cm), 12" (30.4 cm), and 16" (40.6 cm) dial sizes
- Offered in a low-profile metal case or SlimLine ABS case
 - Optional Cherry Wood finish or Brushed Aluminium finish
- Power over Ethernet (802.3af standard)
 - Power and data are provided through one standard network cable (CAT 5, CAT 5e, or CAT 6)
- Provided with mounting hardware for easy installation
- Hour, minute, and second hands
- Quick correction for time change (max. 5 minutes)
- Microprocessor based movement
- Side molded, polycarbonate crystal

Highlights:

- Built-in web interface - each clock has a built in web interface allowing the user to set, control, and monitor the IP clock
 - Built-in web interface settings include: Network settings, NTP server selection, UTC/GMT offset selection, automatic Daylight Saving Time adjustments, and much more!
- Receives time data from one of ten pre-programmed third party NTP servers (user changeable) for added reliability and redundancy. Alternatively, it can be set to receive the time data from an in-house NTP Server or from any Master Clock model.
- Built-in self-diagnostics and email alerts for:
 - NTP Synchronization Timeouts
 - Power resets
 - Hand position errors and corrections
- Interfaces with IP Clock Monitor software which will allow the user to view, monitor, and send various commands to all IP clocks in the system
- Custom Color Cases available (minimum quantity 25)



SSIAP Series IP Round Clock (V1.0)

Specifications:

Case Material:

Steel or ABS.
Cherry wood finish or brushed aluminum finish for the SlimLine ABS case are also available.

Case Color:

Standard black finish (custom colors available)

Dial Face:

12 or 24 (military) hour standard
Specialty dials available

Dial Material:

Durable polystyrene

Crystal Material:

Shatter-proof, side-molded, transparent polycarbonate

Data Protocols:

NTP, SNTP, Simplex Proprietary

Routing Protocols:

IPv4

Voltage Input:

48 VDC (PoE powered)

Average Current Consumption:

70mA @ 48 VDC (PoE Class 1)

Hand tolerance:

Minute hand: +/- 1/4 minute
Second hand: +/- 1/2 second

Temperature range:

Operating: 32°F - 113°F (0°C - 45°C)
Shelf: 5°F - 167°F (-15°C - 75°C)

Compliance:

UL, cUL listed



Ordering Information:

SSIAP Series IP Round Clock: SSIAP-XXS-XXR-0-XX

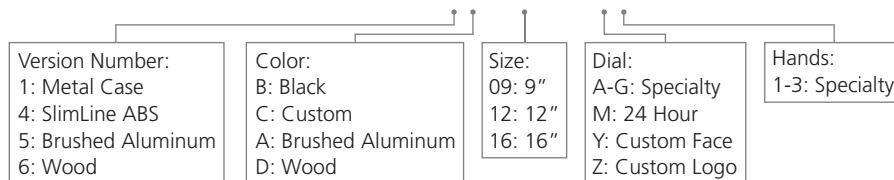

Double Mount Housing: SAX-XXD-XXR-0X

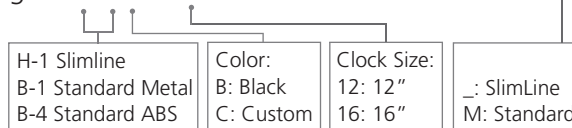

Note: Purchasing double mounted round analog clocks will require two clocks using the clock part number and one double mount housing using the part number above.

*Note: SlimLine and Aluminum clocks use the SlimLine Adapter.

Examples:

SSIAP-6DS-09R-0: Simplex Analog, SlimLine IP, 9" Round, PoE, Surface Wall Mount, Solid Cherry Wood Frame
SSIAP-5AS-12R-0: Simplex Analog, SlimLine IP, 12" Round, PoE, Surface Wall Mount, Brushed Aluminum Case

SSIAP Series IP Round Clock (V1.0)

Simplex Round Analog Clock Dimensions

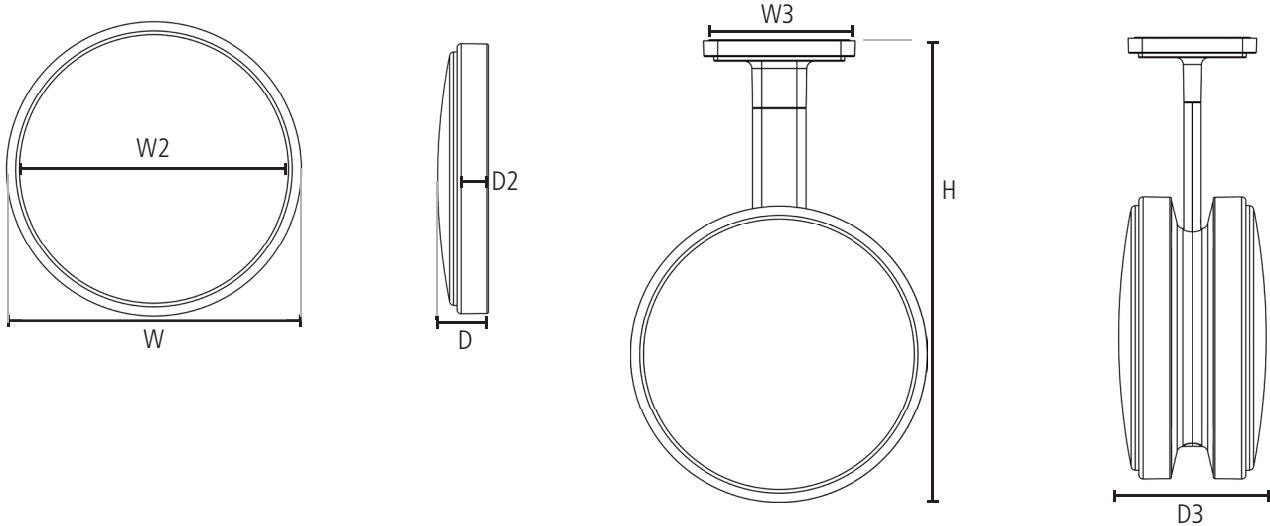

SLIMLINE ABS

Clock Size:	9" SlimLine	12" SlimLine	16" SlimLine
W	9.8" (24.8cm)	12.9" (32.7cm)	16.7" (42.3cm)
W2	9.5" (24.2cm)	12.6" (32.0cm)	16.3" (41.5cm)
D	2.4" (6.2cm)	2.4" (6.2cm)	2.5" (6.4cm)
D2	1.7" (4.2cm)	1.7" (4.3cm)	1.7" (4.4cm)
Shipping Weight:	2 lbs (0.9 kg)	2 lbs (0.9 kg)	4 lbs (1.8 kg)
Double/Dual Mount Dimensions:	Not Applicable	W3 = 6.6" (16.7cm) D3 = 6.4" (16.2cm)	W3 = 6.6" (16.7cm) D3 = 6.4" (16.3cm)
Adjustable Pole Height:	Not Applicable	H = 19.7" (50.2cm) = 18.1" (46.1cm) = 16.5" (41.9cm)	H = 21.7" (55.3cm) = 20.1" (51.2cm) = 18.5" (47.0cm)

ALUMINUM

WOODEN

Clock Size:	9" Aluminum	12" Aluminum	16" Aluminum	9" Wood	12" Wood	16" Wood
W	10.7" (27.1cm)	13.8" (35.0cm)	17.8" (45.1cm)	11.6" (29.5cm)	13.3" (33.8cm)	19.6" (49.9cm)
W2	9.5" (24.2cm)	12.6" (32.0cm)	16.3" (41.5cm)	9.5" (24.2cm)	12.6" (32.0cm)	16.5" (41.5cm)
D	2.4" (6.2cm)	2.4" (6.2cm)	2.4" (6.4cm)	D* = 2.4" (6.2cm)	D* = 2.4" (6.2cm)	D* = 2.4" (6.4cm)
D2	1.7" (4.2cm)	1.7" (4.4cm)	1.7" (4.4cm)	D2* = 2.7" (6.8cm)	D2* = 2.7" (6.8cm)	D2* = 2.7" (6.8cm)
Shipping Weight:	2 lbs (0.9kg)	3 lbs (1.4 kg)	4 lbs (1.8 kg)	3 lbs (kg)	4 lbs (1.8 kg)	6 lbs (2.7 kg)
Double/Dual Mount Dimensions:	Not Applicable	W3 = 6.6" (16.7cm) D3 = 6.4" (16.2cm)	W3 = 6.6" (16.7cm) D3 = 6.4" (16.3cm)	Not Applicable	Not Applicable	Not Applicable
Adjustable Pole Height:	Not Applicable	H = 20.2" (51.5cm) = 18.6" (47.3cm) = 17.0" (43.2cm)	H = 22.3" (56.6cm) = 20.6" (52.4cm) = 19.0" (48.2cm)	Not Applicable	Not Applicable	Not Applicable

***NOTE:** For wood clocks, the rim (D2) protrudes further from the wall than the crystal (D).

Hand & Dial Options



Standard Hands

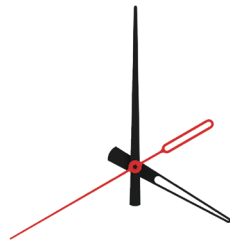

Specialty Hands 1

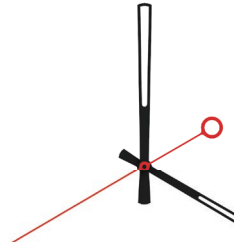

Specialty Hands 2

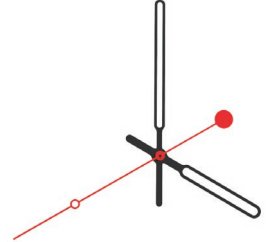

Specialty Hands 3

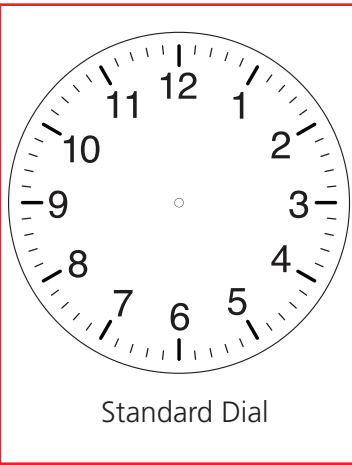

Standard Dial

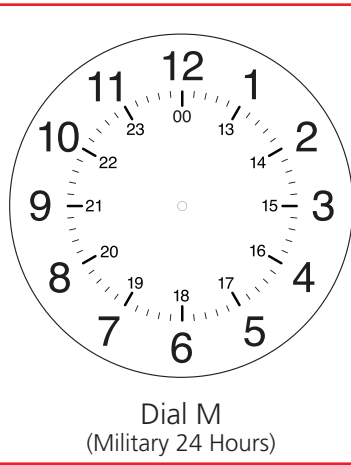

Dial M
(Military 24 Hours)

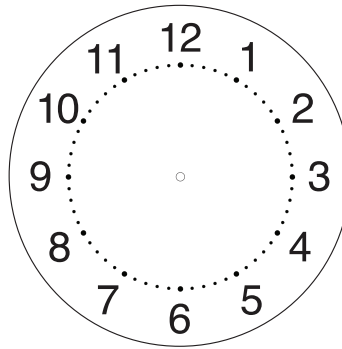

Dial A

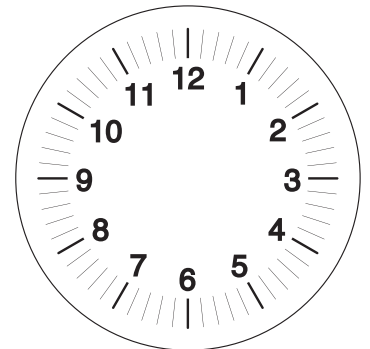

Dial B

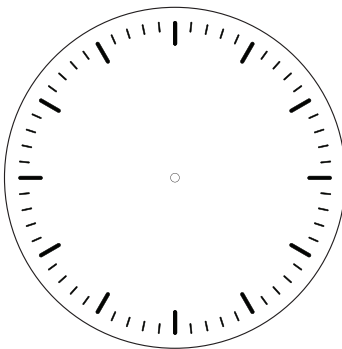

Dial C

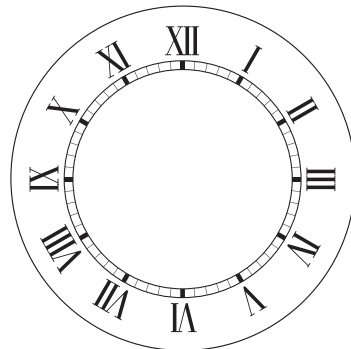

Dial E

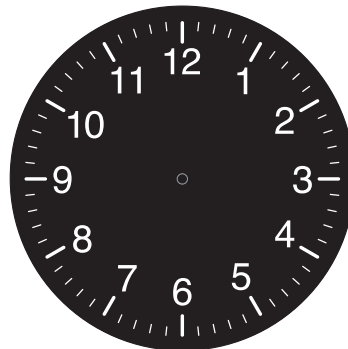

Dial F

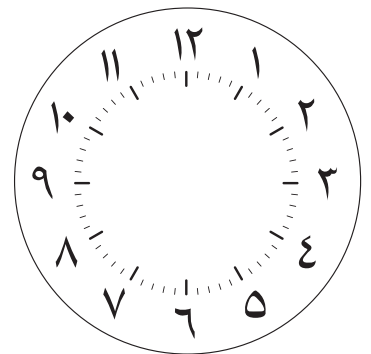

Dial G

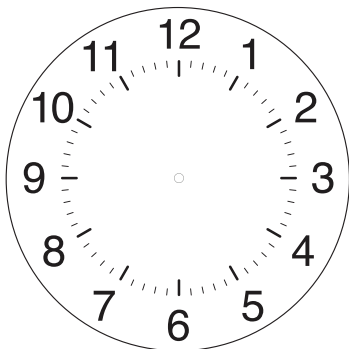

Dial S

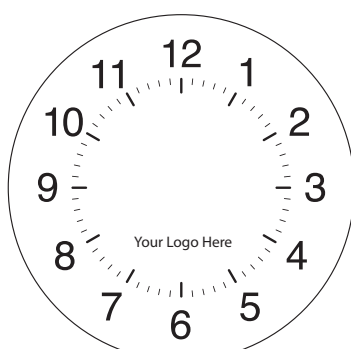

Dial Z

Specialty Hands 1-3 & Specialty Dials A-Z are offered at an additional cost.

For more information please contact your Simplex Representative.

specification sheets may change without prior notice

SSIAP Series IP Round Clock (V1.0)

Clock Case Options



Standard SlimLine
ABS Case



Brushed Aluminum Finish



Solid Wood Case Cherry Finish

