

SSIALG Series Wireless 2.4GHz Round Clock (V1.0)

Features:

- Available in 9", 12", and 16" dial sizes
- Offered in a SlimLine ABS case
 - Optional Cherry Wood finish or Brushed Aluminum finish
- Multiple power options
 - Offered in 230VAC, and battery-powered models
- Provided with mounting hardware for easy installation
- Hour, minute, and second hands
- Quick correction for time change (max. 5 minutes)
- Microprocessor based movement
- Internal Antenna
- Side molded, polycarbonate crystal
- FCC Compliant per FCC part 15 Section 15,247

Highlights:

- Each clock acts as a repeater for the time data signal
- Energy efficient
- 2.4 GHz frequency hopping technology to ensure signal reliability
 - No FCC License Required
- Receives and repeats the time data
 - Once every minute if locally powered
 - Once every two hours in standard mode, or once every four hours in economy mode if battery powered
- Built-in self-diagnostic mode:
 - Signal reception strength
 - Clock movement testing
 - Battery level if battery-powered
- Custom Color Cases available (minimum order quantity 25)

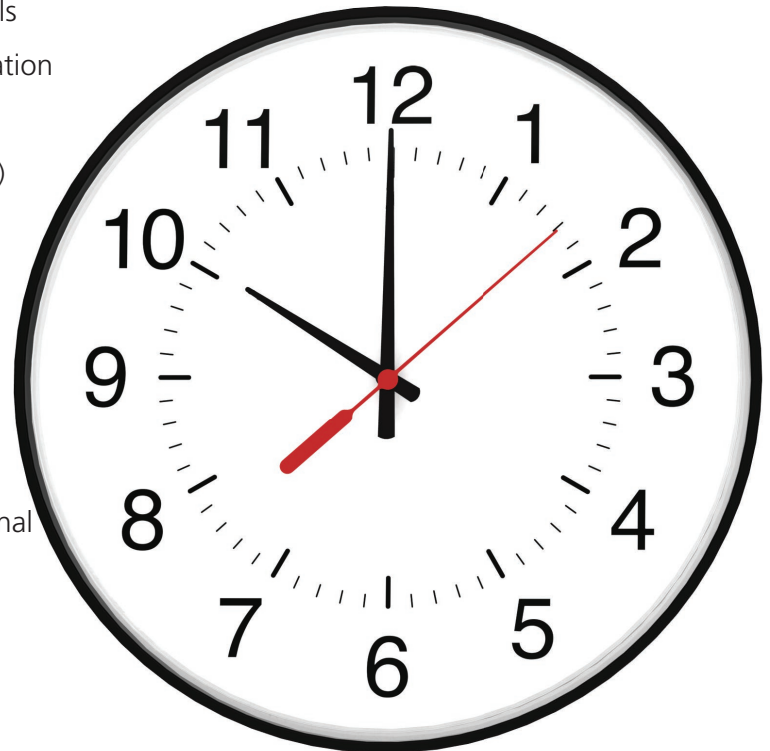

SSIALG Series Wireless 2.4GHz Round Clock (V1.0)

Specifications:

Case Material:

Acrylonitrile Butadiene Styrene (ABS).
Cherry wood finish or brushed aluminum finish for the SlimLine ABS case is also available.

Case Color:

Standard black finish (custom colors available)

Dial Face:

12 or 24 (military) hour standard
Specialty dials available

Dial Material:

Durable polystyrene

Crystal Material:

Shatter-proof, side-molded, transparent polycarbonate

Voltage Input:

Two 1.5V "D" Cell Alkaline Batteries (Battery model)
11 - 28 VDC/VAC 50/60 Hz (24V model)
180 - 260 VAC 50/60 Hz (230V model)

Average Current Consumption:

Battery - 5 years (standard mode)
8 years (economy mode)
35 mA @ 24VDC/VAC
15 mA @ 230VAC

Hand tolerance:

Minute hand: +/- 1/4 minute
Second hand: +/- 1/2 second

Temperature range:

Operating: 32°F - 113°F (0°C - 45°C)
Shelf: 5°F - 167°F (-15°C - 75°C)

Operating frequencies:

2.4 GHz while frequency-hopping

Transceiver parameters:

Transmitter power output: 8 dbm
Receiver sensitivity: -103 dbm

Compliance:

UL and cUL listed, FCC part 15 Section 15.247

Ordering Information:

SSIALG Series Wireless Round Clock: SSIALG-XXS-XXR-X-XX

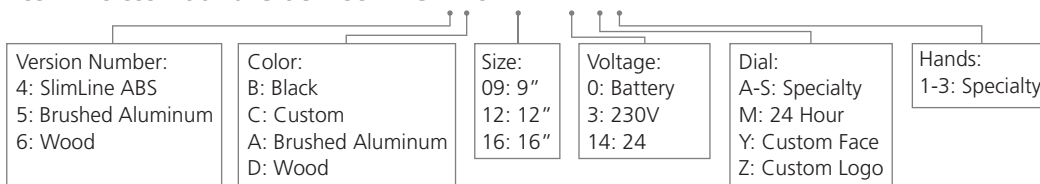

Double Mount Housing: SAH-1XD-XXR-0

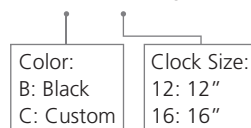

Note: Purchasing double mounted round analog clocks will require two clocks using the clock part number and one double mount housing using the part number above.

Examples:

SSIALG-5AS-09R-0 Simplex Analog, Wireless SlimLine, 2.4 GHz, 9" Round, Battery-Operated, Surface Wall Mount, Brushed Aluminum Case
SSIALG-6DS-16R-14 Simplex Analog, Wireless SlimLine, 2.4 GHz, 16" Round, 24VAC, Surface Wall Mount, Solid Cherry Wood Frame

SSIALG Series Wireless 2.4GHz Round Clock (V1.0)

Simplex Round Analog Clock Dimensions

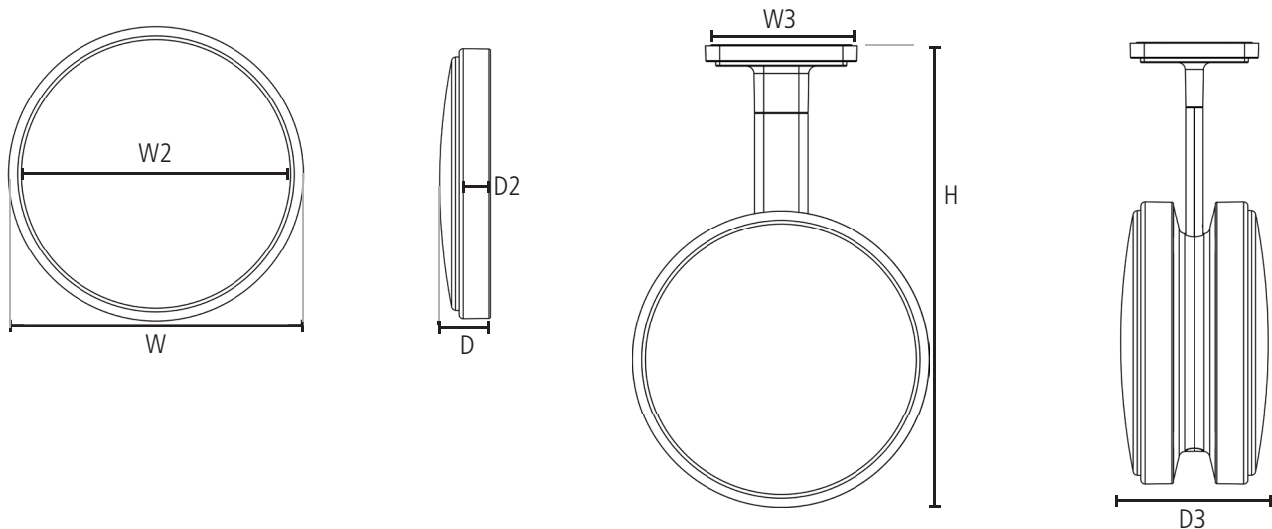

SLIMLINE ABS

| Clock Size: | 9" SlimLine | 12" SlimLine | 16" SlimLine |
|-------------------------------|----------------|--|--|
| W | 9.8" (24.8cm) | 12.9" (32.7cm) | 16.7" (42.3cm) |
| W2 | 9.5" (24.2cm) | 12.6" (32.0cm) | 16.3" (41.5cm) |
| D | 2.4" (6.2cm) | 2.4" (6.2cm) | 2.5" (6.4cm) |
| D2 | 1.7" (4.2cm) | 1.7" (4.3cm) | 1.7" (4.4cm) |
| Shipping Weight: | 2 lbs (0.9 kg) | 2 lbs (0.9 kg) | 4 lbs (1.8 kg) |
| Double/Dual Mount Dimensions: | Not Applicable | W3 = 6.6" (16.7cm) D3 = 6.4" (16.2cm) | W3 = 6.6" (16.7cm) D3 = 6.4" (16.3cm) |
| Adjustable Pole Height: | Not Applicable | H = 19.7" (50.2cm) = 18.1" (46.1cm) = 16.5" (41.9cm) | H = 21.7" (55.3cm) = 20.1" (51.2cm) = 18.5" (47.0cm) |

ALUMINUM

WOODEN

| Clock Size: | 9" Aluminum | 12" Aluminum | 16" Aluminum | 9" Wood | 12" Wood | 16" Wood |
|-------------------------------|----------------|--|--|--------------------|--------------------|--------------------|
| W | 10.7" (27.1cm) | 13.8" (35.0cm) | 17.8" (45.1cm) | 11.6" (29.5cm) | 13.3" (33.8cm) | 19.6" (49.9cm) |
| W2 | 9.5" (24.2cm) | 12.6" (32.0cm) | 16.3" (41.5cm) | 9.5" (24.2cm) | 12.6" (32.0cm) | 16.5" (41.5cm) |
| D | 2.4" (6.2cm) | 2.4" (6.2cm) | 2.4" (6.4cm) | D* = 2.4" (6.2cm) | D* = 2.4" (6.2cm) | D* = 2.4" (6.4cm) |
| D2 | 1.7" (4.2cm) | 1.7" (4.4cm) | 1.7" (4.4cm) | D2* = 2.7" (6.8cm) | D2* = 2.7" (6.8cm) | D2* = 2.7" (6.8cm) |
| Shipping Weight: | 2 lbs (0.9kg) | 3 lbs (1.4 kg) | 4 lbs (1.8 kg) | 3 lbs (kg) | 4 lbs (1.8 kg) | 6 lbs (2.7 kg) |
| Double/Dual Mount Dimensions: | Not Applicable | W3 = 6.6" (16.7cm) D3 = 6.4" (16.2cm) | W3 = 6.6" (16.7cm) D3 = 6.4" (16.3cm) | Not Applicable | Not Applicable | Not Applicable |
| Adjustable Pole Height: | Not Applicable | H = 20.2" (51.5cm) = 18.6" (47.3cm) = 17.0" (43.2cm) | H = 22.3" (56.6cm) = 20.6" (52.4cm) = 19.0" (48.2cm) | Not Applicable | Not Applicable | Not Applicable |

*NOTE: For wood clocks, the rim (D2) protrudes further from the wall than the crystal (D).

SSIALG Series Wireless 2.4GHz Round Clock (V1.0)

Hand & Dial Options



Standard Hands



Specialty Hands 1

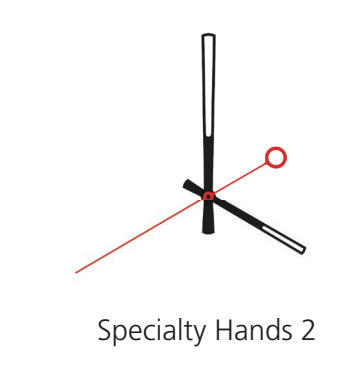

Specialty Hands 2

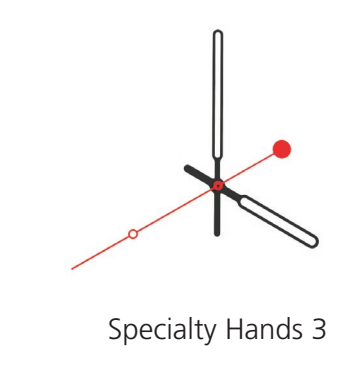

Specialty Hands 3

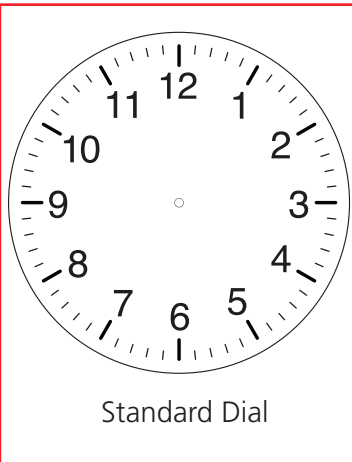

Standard Dial

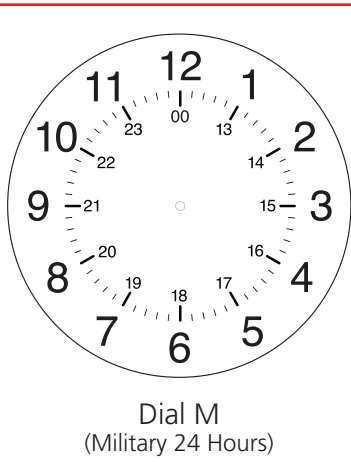

Dial M
(Military 24 Hours)

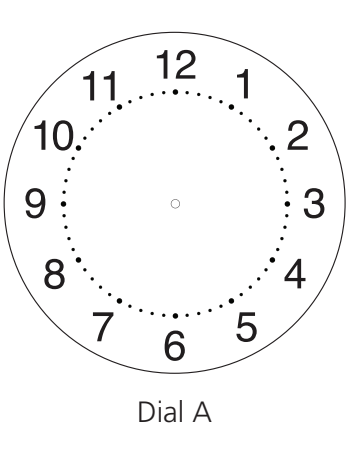

Dial A

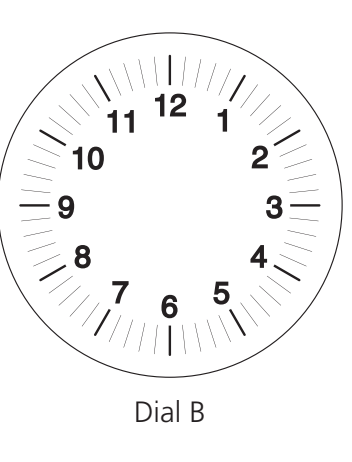

Dial B

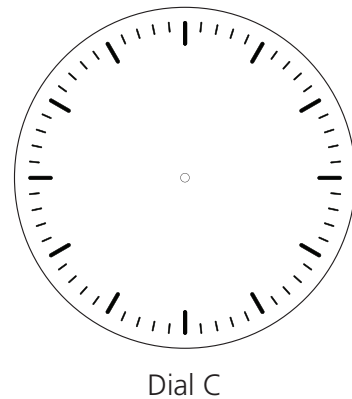

Dial C

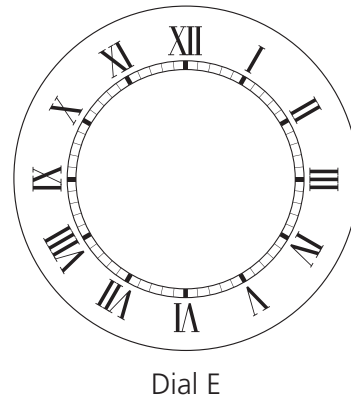

Dial E

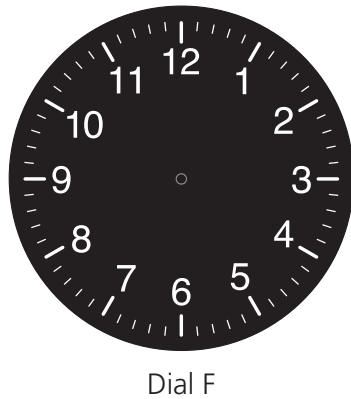

Dial F



Dial G

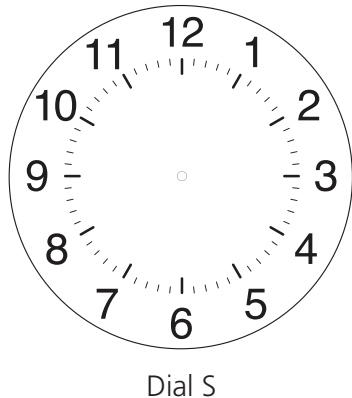

Dial S



Dial Z

Specialty Hands 1-3 & Specialty Dials A-Z are offered at an additional cost.

For more information please contact your Simplex Representative.

SSIALG Series Wireless 2.4GHz Round Clock (V1.0)

Clock Case Options



Standard SlimLine
ABS Case



Brushed Aluminum Finish



Solid Wood Case Cherry Finish

