

 Simplex

EP800

USER'S MANUAL

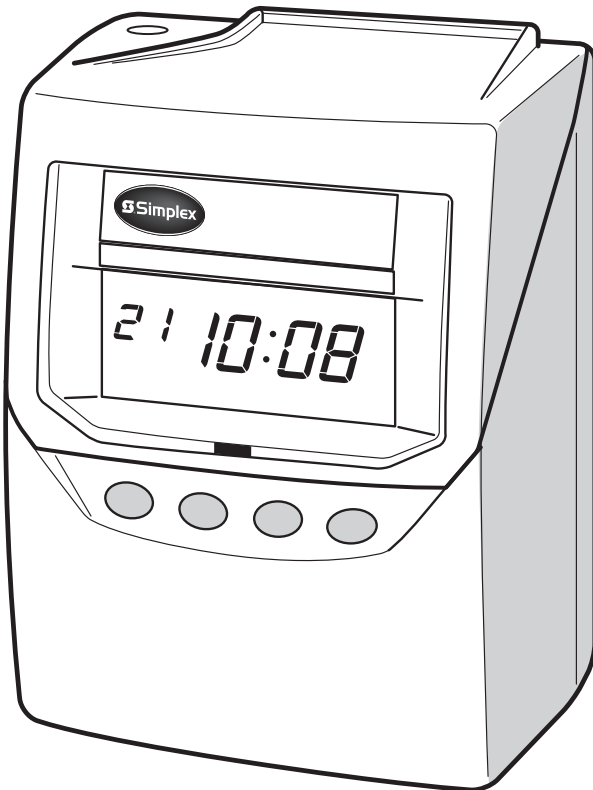

WARNING

This equipment has been tested and found to comply with the limits for a Class A digital device, pursuant to Part 15 of FCC Rules. These limits are designed to provide reasonable protection against harmful interference when the equipment is operated in a commercial environment. This equipment generates, uses, and can radiate radio frequency energy and, if not installed and used in accordance with the instruction manual, may cause harmful interference to radio communications. Operation of this equipment in a residential area is likely to cause harmful interference in which case the user will be required to correct the interference at his or her own expense.

Caution: Changes or modifications not expressly approved by the party responsible for compliance could void the user's authority to operate the equipment.

THIS DIGITAL APPARATUS DOES NOT EXCEED THE CLASS A LIMITS FOR RADIO NOISE EMISSIONS FROM DIGITAL APPARATUS AS SET OUT IN THE RADIO INTERFERENCE REGULATIONS OF THE CANADIAN DEPARTMENT OF COMMUNICATIONS.

LE PRÉSENT APPAREIL NUMÉRIQUE N'ÉMET PAS DE BRUITS RADIOÉLECTRIQUES DÉPASSANT LES LIMITES APPLICABLES AUX APPAREILS NUMÉRIQUES DE CLASSE A PRESCRITES DANS LE RÈGLEMENT SUR LE BROUILLAGE RADIOÉLECTRIQUE ÉDICTÉ PAR LE MINISTÈRE DES COMMUNICATIONS DU CANADA.

Simplex EP800
User's Guide

© 2011 SimplexGrinnell LP. All rights reserved.

SimplexGrinnell is continually improving its products; specifications are subject to change without notice.

SimplexGrinnell, Simplex and Be Safe are trademarks of Tyco International Services AG or its affiliates.

License numbers available at www.simplexgrinnell.com or contact your local SimplexGrinnell office.

MC109-151-614

TABLE OF CONTENTS

1. INTRODUCTION	1
Accessories	1
Features	1
2. QUICK SETUP	3
Installing Ribbon Cassette	3
Display Hours	5
Time Zone	6
Default Settings	7
Advanced Settings Contents	8
Installing the Unit	9
Environmental Conditions	9
3. ADVANCED SETTINGS	11
Time	11
Date	12
Payroll Mode, Weekly	14
Payroll Mode, Monthly	15
Payroll Mode, Bi-Weekly	16
Payroll Mode, Semi-Monthly	17
Job-Cost	18
Print Format	19
Rounding	21
Auto Break Deduction	23
Max In	25
Button Function	26
Daylight Savings Time	28
Disable Daylight Savings Time	31
Print Language	32
4. OPERATIONS & FUNCTIONS	33
Radio Signal Reception	34
Reset Settings	35
Reset Cards in Job Cost Mode	36
Card Reassign	37
All Cards Reset	38
5. PRINT EXAMPLE	40
6. INSTALLING Ni-Cd BATTERY (Optional)	41
7. TROUBLESHOOTING	42
8. WARNINGS & CAUTIONS	44
9. SPECIFICATIONS	45

1. INTRODUCTION

Accessories

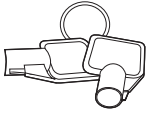

Keys
(P/N: 1409-5030)

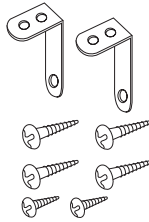

Wall mount hardware

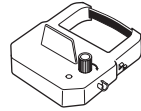

Ribbon cassette
(P/N: 1409-5010 purple)

MUST USE THE 1950-4301 CARD FROM LATHEM TO INSURE PROPER OPERATION.

An optional battery is sold separately (P/N: 1410-5020) to provide 100% operation of card print mechanism during power failures.

Features

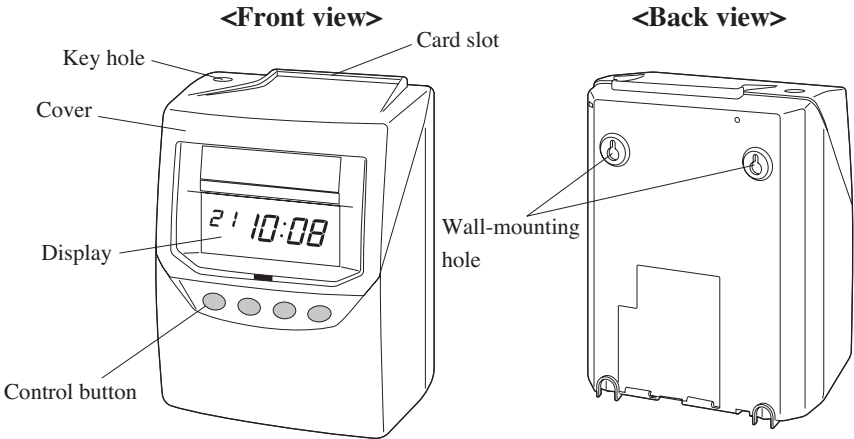

< Display >

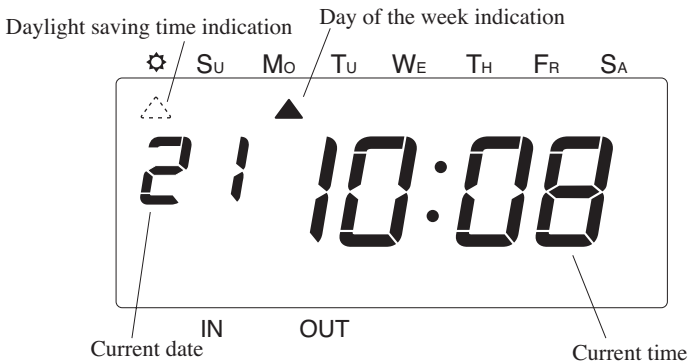

INTRODUCTION

About Your Atomic Clock

In addition to a regular quartz time clock, the Model EP800 contains an antenna and a microchip. The antenna receives the official time signal from the U.S. Government's National Institute of Standards and Technology and the microchip translates the time signal and adjusts the time display to the correct time. The Model EP800 receives a 60-kilohertz, low frequency AM radio signal from the WWVB radio station maintained by the National Institute of Standards and Technology (NIST). The NIST, using its atomic clock, is the official timekeeper for the U.S. and is located in Boulder, Colorado. The Model EP800 will work anywhere it can receive the WWVB signal from the NIST. This signal is broadcast to reach across the continental U.S. and into parts of Canada and Mexico. To learn more about the NIST time correction technology used in the Model EP800, you can visit: <http://www.nist.gov/pml/div688/grp40/wwvb.cfm>

2. QUICK SETUP

This setup should take approximately ten to fifteen minutes to complete if you use the default settings. For this setup, take the clock to a comfortable position that has access to power.

Installing Ribbon Cassette

MAKE SURE THE POWER IS ON BEFORE INSTALLING.

- 1 Hold the left and right sides of the cover and lift up. Then, lift up the antenna case.

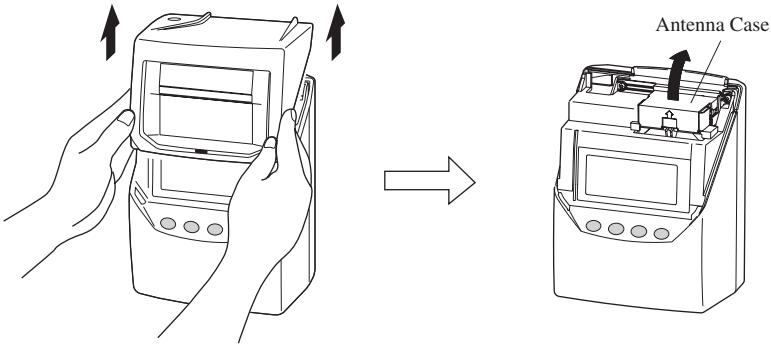

- 2 Turn the knob of the new ribbon cassette in the same direction as the arrow to tighten the ribbon.

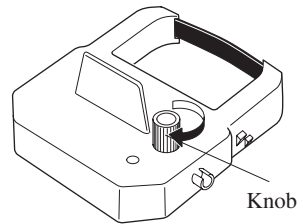

- 3 Place the ribbon cassette inside the time recorder as shown in the figure. Push the ribbon cassette until it snaps into the clasps on both sides. If it is difficult to insert the ribbon cassette, try it while turning the knob.

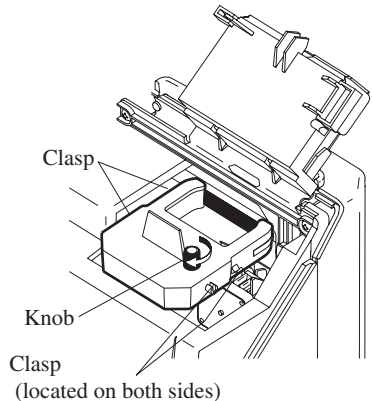

- 4 Install the ribbon cassette so that the ribbon is between the print head and the ribbon mask (see the figure on the left). Printing will not come out properly if the ribbon is placed behind the ribbon mask (see the figure on the right).

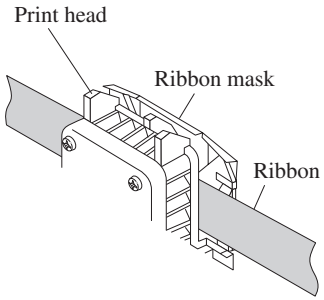

CORRECT

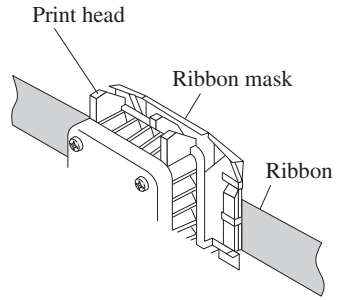

WRONG

- 5 Turn the knob of the ribbon cassette in the direction of the arrow to tighten the ribbon.

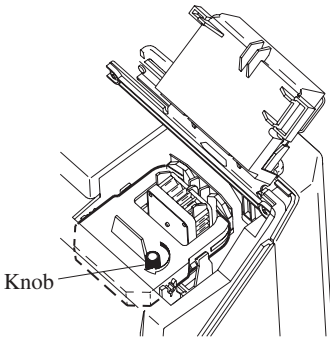

- 6 Set the antenna case down. Leave the cover off while changing any settings in the next step. When the settings are complete, replace the cover.

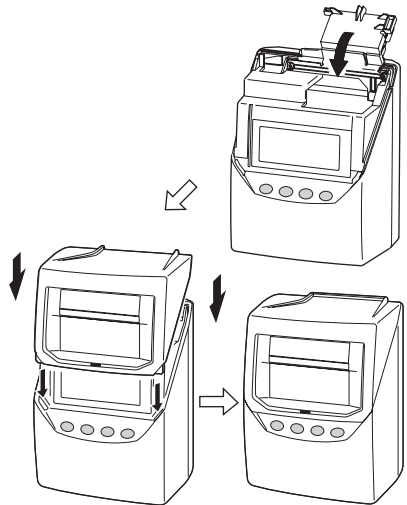

Setting the Display Hours

"Display Hours" is the format that the hours appear on the clock face. The default is "AM/PM".

	Type of Hour	
1	AM/PM (12 hour)	For example, PM 2:55
2	24 hour	For example, 14:55

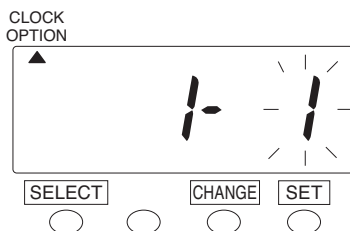
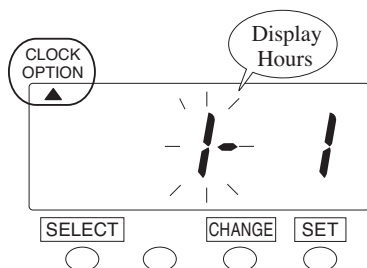

Set the "Display Hours".

- 1 Push the **DATE/TIME** button for 5 seconds and position the "▲" under the "CLOCK OPTION" mark.

A flashing number can be changed.

- 2 Push the **CHANGE** button to select either "1" for AM/PM or "2" for 24 hour with the left-side number.

- 3 Push the **SET** button to confirm the setting. At that moment, the flashing of display will change to the right-side number. The unit is set to "1" for the Eastern Time Zone. If you need to change the time zone for atomic clock function, go to Setting the Time Zone for Atomic Clock Function.

If you don't need to change the time zone setting shown on the display, push the **SET** button two more times to finish the setting. Then, the unit starts reception of the WWVB radio signal.

Setting the Time Zone for Atomic Clock Function

The Model EP800 can be set to one of the four United States time zones. Additionally, two more options including no reception of WWVB signal are available with this model. By default, the unit is shipped preset to Eastern Time.

	Order Option	Notes
1	Eastern	Default
2	Central	
3	Mountain	
4	Pacific	
5	Other	Adjusts just "minute" and "second" by the WWVB radio signal. You must set "date" and "time" to your local time first before starting reception of the WWVB signal.
6	No Reception	Disables atomic clock function and does not adjust time by the WWVB radio signal.

Important Note: To set the Time Zone for Atomic Clock Function, you must start at Step 1 of "Setting the Display Hours". Continue from Step 3 of "Setting the Display Hours" to Step 4 of "Setting the Time Zone".

Example: Change the time zone to "Central".

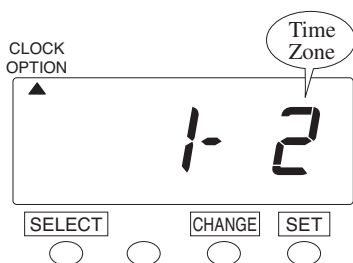

- 4** In case of the example, push the **CHANGE** button to set at "2", and then push the **SET** button to finish the setting. At that moment, the display will change from flashing to steady and the setting is now completed.

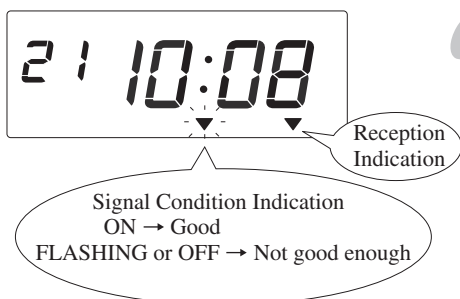

- 5** Push the **SET** button once again. Then the unit starts reception of the WWVB radio signal.

Please see "Radio Signal Reception" on page 34 for more information on the WWVB signal.

DEFAULT SETTINGS

All of the settings have defaults that are already set. If these settings in the following list are acceptable, you do not have to do anything. If you would like to change any of these settings, please review the alternative options available in the Advanced Settings contents list on page 8.

Setting	Explanation	Default Setting
Display Hours	How the hours are displayed on clock face	AM/PM For example, PM 2:55
Time Zone	When using WWVB, clock's time will be set to this time zone.	Eastern time zone
Time	Current time	Eastern Standard Time
Date	Current date	Current date
Mode	Schedule that the clock will operate with start day	Payroll (Weekly), Monday for the starting day
Print Format	Format that prints on time card when punched	Day of the week, AM/PM, and regular minutes For example, FR 4:30P
Rounding	Clock can calculate total hours and minutes with rounding rules	No rounding, prints totals calculated to exact minute
Auto Break Deduction	Clock will discount break when a given amount of hours are calculated	None, employees should punch in/out for breaks if they are not paid
Max In	Clock will assume that an "OUT" punch is missed after a given number of hours.	The next punch made by anyone 'in' more than 13 hrs. will be recorded as the next 'in'
Button Function (IN/OUT)	How the user operates the "IN" and "OUT" buttons	Clock will automatically position; User can override
Daylight Savings Time	Clock will change automatically for Daylight Savings Time	Yes, will change 2nd Sunday of March and 1st Sunday of November
Print Language	Language that month and days of the week are printed	English

Please go to "Installing the Unit" on page 9 when you are finished with the settings.

ADVANCED SETTINGS CONTENTS

If you choose to change any of the optional settings below, remove the top and go to the page as noted next to the optional setting.

Setting	Explanation of Optional Settings	Page
Display Hours	24 hour, for example, 14:55	5
Time Zone	Central, Mountain, or Pacific Adjust only minute and seconds by WWVB No adjustment by WWVB	6
Time		11
Date		12
Mode	Payroll, Monthly Payroll, Bi-Weekly Payroll, Semi-Monthly Job-Cost	15 16 17 18
Print Format	Date, 24 hour, and hundredths (these can be chosen individually)	19
Rounding	6 minute with 3 minute breakpoint 15 minute with 3 minute breakpoint 15 minute with 7 minute breakpoint	21
Auto Break Deduction	Enter elapsed time and break duration	23
Max In	Deactivate or change number of hours	25
Button Function (IN/OUT)	IN/OUT Button punch required before printing or IN/OUT Buttons disabled	26
Daylight Savings Time	Can change DST to new dates for Daylight Savings Time or Disable Daylight Savings Time	28 31
Print Language	French, Spanish	32

Please go to "Installing the Unit" on page 9 when you are finished with the settings.

INSTALLING THE UNIT

Note: The unit has an internal battery that will save the settings when unplugged.

The unit can be used on a table-top or mounted on a wall. When choosing a location, please note locations to avoid in "Environmental Conditions" at the bottom of the page. If you are using the unit as a table-top, find an appropriate place and skip to Step 3. If using as a wall-mount, take the following steps.

Mounting Unit on Wall

The unit can be mounted on a wall using the supplied mounting fittings.

- 1 Install wall mount screws (supplied) into a wall $3\ 15/16"$ (10 cm) apart. Be sure to keep about $1/8"$ (3mm) of the screw head out of the wall. Use template on bottom of page 10 if you prefer.



The supplied screws are intended for use on a thick wooden wall or wooden column. Do not use them on any other materials. There is a danger that the unit may come off if used on other materials.

- 2 Mount the wall mount fittings as shown on the right.
- 3 Plug the unit into power, and the unit is ready to use.

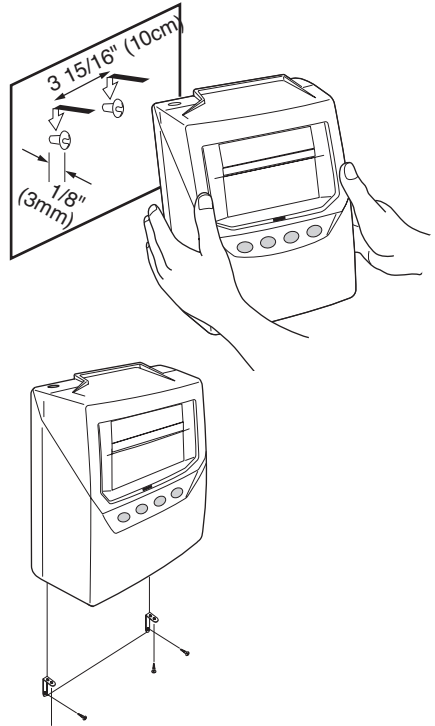

Environmental Conditions

Avoid placing the unit in environments that are:

- humid or dusty
- exposed to direct sunshine
- subject to frequent or continuous vibrations
- outside the temperature range between 23°F (-5°C) and 113°F (45°C)
- affected by chemicals or ozone

Template for wall mounting

Please copy and use this page when needed.

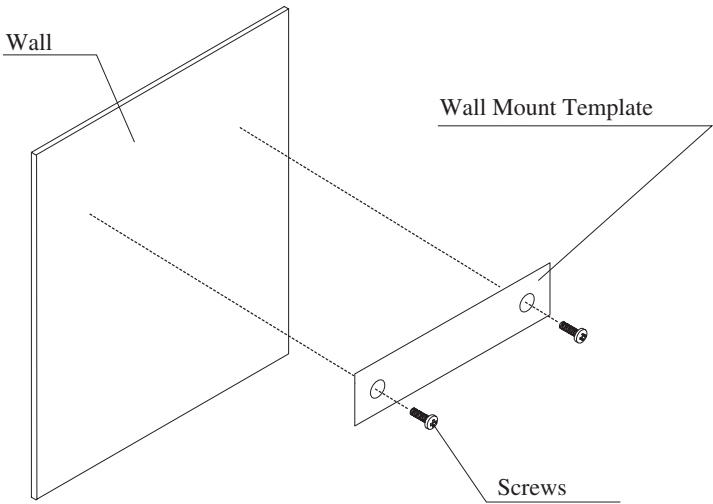

Leave about 1/8" gap between wall and screw head.



3. ADVANCED SETTINGS

Setting the Time

Example: Change the time from 10:08 a.m. to 10:09 a.m.

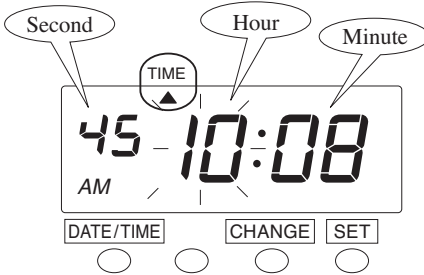

- 1 Push the **DATE/TIME** button for 5 seconds.
- 2 Push the **DATE/TIME** button and position the "▲" under the "TIME" mark.

The flashing number can be changed.

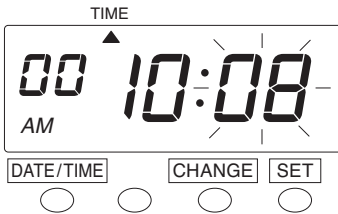

- 3 Press the **CHANGE** button to change the hour. In the example, the hour is not to be changed. Push the **SET** button to accept, the flashing of the display changes from "Hour" to "Minute".

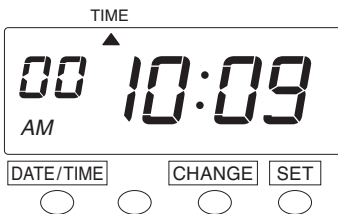

- 4 Changing the "Minute" (for example, from 8 minutes to 9 minutes). Push the **CHANGE** button to set "Minute" at "09" and then push the **SET** button. Now the minutes of 9 have been set.
- 5 Push the **SET** button once again.

You have completed this setting. Go to the next setting listing in "Default Settings" on page 7 to continue with the setup.

Setting the Date

Example: Change the date from October 20, 2009 to October 21, 2009.

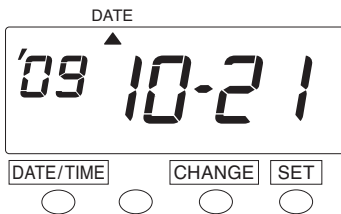
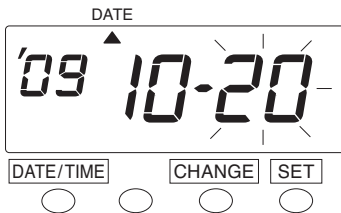
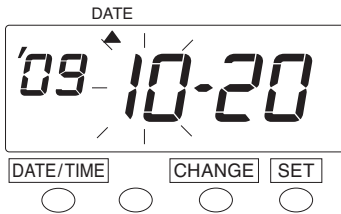
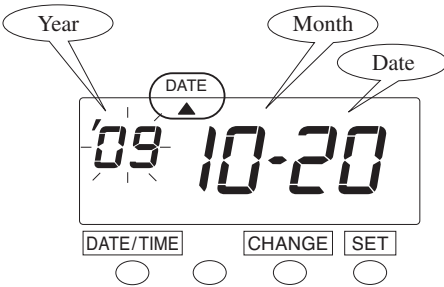

- 1 Push the **DATE/TIME** button for 5 seconds.
- 2 Push the **DATE/TIME** button twice to position the "▲" under the "DATE" mark.

A flashing number means that it can be changed.

- 3 In the example, push the **SET** button because the year 2009 is not to be changed. Now the year of 2009 has been set.

At that moment, the flashing of the display will change from "Year" to "Month".

- 4 In the example, push the **SET** button because the month of October is not to be changed. Now October has been set.

At that moment, the flashing of the display will change from "Month" to "Date".

- 5 Change "Date" (for example, from 20 to 21)

Push the **CHANGE** button to set "Date" at "21" and then push the **SET** button, and now the date of 21 has been set.

At that moment, "Date" on the display will change from flashing to steady, and the date change setting is now completed.

- 6 Push the **SET** button once again.

You have completed this setting. Go to the next setting listing in "Default Settings" on page 7 to continue with the setup.

Setting the Mode

This time recorder can operate in one of two modes; **Payroll Mode or Job Cost Mode.**

In Payroll Mode and Job Cost Mode, the recorder prints total elapsed time between IN(Start) and OUT(Stop), and also prints a running total of accumulated time per time card on each line. The clock matches pairs of punches and calculates the elapsed time between that pair using predefined rounding rules. The recorder always prints the actual time on the time card, regardless of rounding rules. In Payroll Mode the hours accumulate and reset based on "pay period settings" that are configured during setup. In Job Cost Mode the hours for each unique card can accumulate and reset based on "manual card reset" ("cleared") by performing a manual operation on the time recorder.

	Order Option	
1	Monthly	}
2	Weekly	
3	Bi-Weekly	}
4	Semi-Monthly	
5	JOB COST	

The diagram shows a table with five rows. The first two rows (Monthly and Weekly) are grouped by a bracket on the right, with a callout bubble labeled "Payroll Mode". The last three rows (Bi-Weekly, Semi-Monthly, and JOB COST) are grouped by a bracket on the right, with a callout bubble labeled "Job Cost Mode".

Payroll Mode

- To set to "Weekly" period, go to page 14.
- To set to "Monthly" period, go to page 15.
- To set to "Bi-Weekly" period, go to page 16.
- To set to "Semi-Monthly" period, go to page 17.

Setting Weekly Period in Payroll Mode

Example: Weekly period in Payroll Mode ----- the start day is Monday.

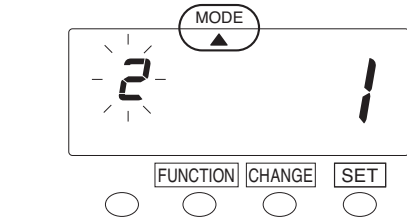

- 1 Push the **FUNCTION** button for 5 seconds and make sure the "▲" is positioned under the "MODE" mark.

Set the "Mode".

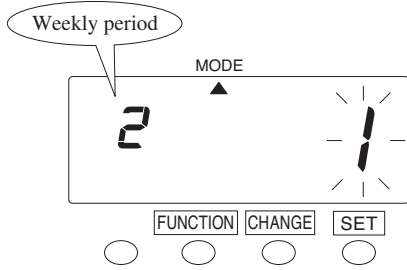

- 2 In the case of weekly period, push the **CHANGE** button to set the left-side number at "2" and then push the **SET** button. At that moment, the flashing of the display will change to the right-side number.

Set the "Starting day of the week".

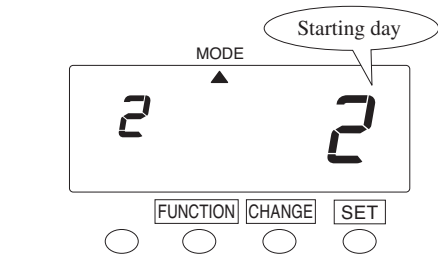

- 3 Starting day

1	Sunday	5	Thursday
2	Monday	6	Friday
3	Tuesday	7	Saturday
4	Wednesday		

To set pay period, you have to input a starting day. In this case, you have to set Monday.

Push the **CHANGE** button to set at "2" and then push the **SET** button.

- 4 Push the **SET** button once again.

You have completed this setting. Go to the next setting listing in "Default Settings" on page 7 to continue with the setup.

Setting Monthly Period in Payroll Mode

Example: Monthly period in Payroll Mode ----- the starting date is the 21st.

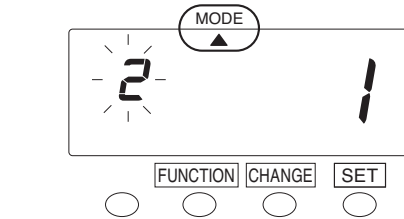

- 1 Push the **FUNCTION** button for 5 seconds and make sure the "▲" is positioned under the "MODE" mark.

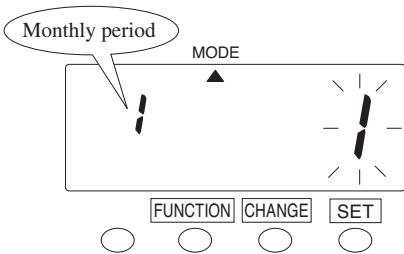

Set the "Mode".

- 2 In the case of monthly period, push the **CHANGE** button to set the left-side number at "1" and then push the **SET** button. At that moment, the flashing of the display will change to the right-side number.

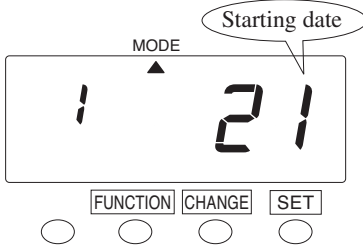

Set the "Starting date".

- 3 To set pay period, you have to input a starting date. In this case, you have to set 21st. Push the **CHANGE** button to set at "21" and then push the **SET** button.

- 4 Push the **SET** button once again.

You have completed this setting. Go to the next setting listing in "Default Settings" on page 7 to continue with the setup.

Setting Bi-Weekly Period in Payroll Mode

Example: Change to Bi-Weekly Period and set the desired starting date of the pay period to October 19.

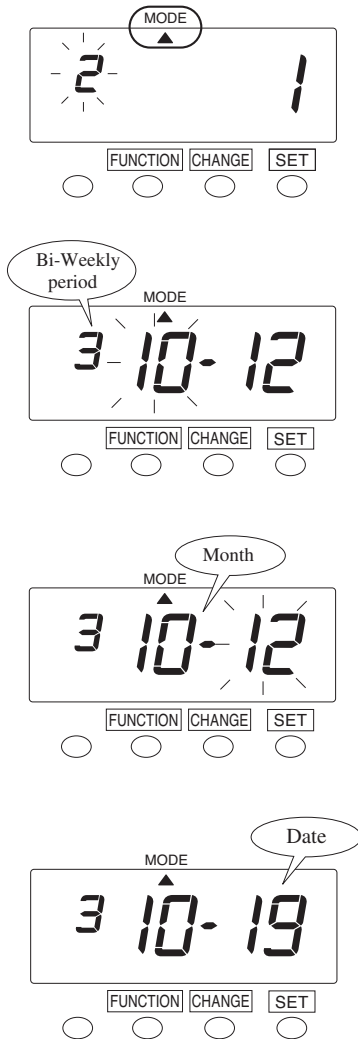

- 1 Push the **FUNCTION** button for 5 seconds and make sure the "▲" is positioned under the "MODE" mark.

Set the "Mode".

- 2 In the case of Bi-Weekly period, push the **CHANGE** button to set the left-side number at "3" and then push the **SET** button. At that moment, the flashing of the display will change to the middle number.

Set the "Starting date".

- 3 You must enter the starting date of the current pay period. For example, if the current date is Wednesday, Oct. 17, and you want the next Bi-Weekly period to start Monday, Oct. 22, enter Monday, Oct. 8 for the starting date.

Now the first day of default pay period is shown. To set pay period, you have to input a starting date. In the example, push the **SET** button because the month of October is not to be changed. At that moment, the flashing of the display will change from "Month" to "Date".

- 4 Change "Date" (for example, from 12 to 19). Push the **CHANGE** button to set "Date" at "19" and then push the **SET** button, and now the date of 19 has been set.

- 5 Push the **SET** button once again.

You have completed this setting. Go to the next setting listing in "Default Settings" on page 7 to continue with the setup.

Setting Semi-Monthly Period in Payroll Mode

Example: Semi-Monthly period in Payroll Mode ----- the starting dates are 1st and 16th.

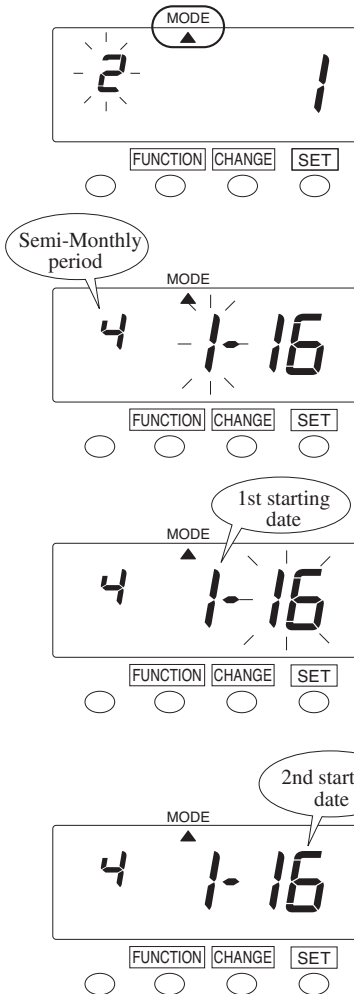

- 1 Push the **FUNCTION** button for 5 seconds and make sure the "▲" is positioned under the "MODE" mark.

Set the "Mode".

- 2 In the case of Semi-Monthly period, push the **CHANGE** button to set the left-side number at "4" and then push the **SET** button. At that moment, the flashing of the display will change to the middle number.

Set the "1st starting date".

- 3 To set pay period, you have to input a starting date. In this case, the 1st starting date is 1st. Push the **CHANGE** button to set at "1" and then push the **SET** button. At that moment, the flashing of the display will change to the right-number.

Set the "2nd starting date".

- 4 In this case, the 2nd starting date is 16th. Push the **CHANGE** button to set at "16" and then push the **SET** button.
- 5 Push the **SET** button once again.

You have completed this setting. Go to the next setting listing in "Default Settings" on page 7 to continue with the setup.

Job Cost Mode

This mode is basically the same as Payroll Mode, but has no pay period. After punching 64 times, the end sign appears.

If you want to be able to reset the card manually without removing the cover, you must select "Reset is YES". See page 36 on "Resetting Cards In Job Cost Mode".

Example: Change to Job Cost Mode and Card "Reset" is YES.

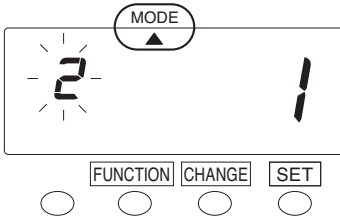

- 1 Push the **FUNCTION** button for 5 seconds and make sure the "▲" is positioned under the "MODE" mark.

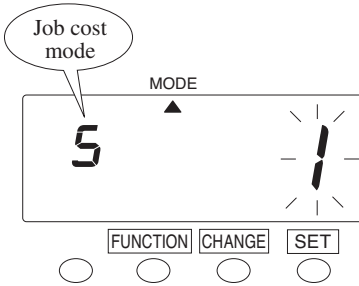

Set the "Mode".

- 2 Push the **CHANGE** button to set the left-side number at "5" and then push the **SET** button. At that moment, the display will change to the right-side number.

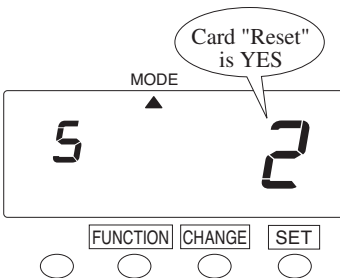

Set the card "Reset".

	Card "Reset"
1	No
2	Yes

Default set to 'No'.

- 3 In this case, push the **CHANGE** button to set at "2" and then push the **SET** button.
- 4 Push the **SET** button once again.

You have completed this setting. Go to the next setting listing in "Default Settings" on page 5 to continue with the setup.

Setting the Print Format

You can select the following "Print Format".

- "Date" or "Day of the week" print format
- "AM/PM" or "24 HR" hour print format
- "Regular" or "Hundredths" minutes print format

If error " E-49 " appears when you try to change settings, then you must reset all cards before proceeding. (See "All cards reset" on page 38.)

The Default setting is "Day of the Week, AM/PM, and Regular Minutes".

Example
 "Day of the week" + "AM/PM" hour + "Regular" minutes
 Example of printing ----- FR 4:30P

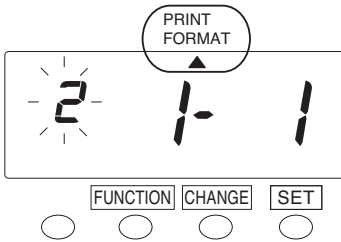

- 1 Push the **FUNCTION** button for 5 seconds.
- 2 Push the **FUNCTION** button and position the "▲" under the "PRINT FORMAT" mark.

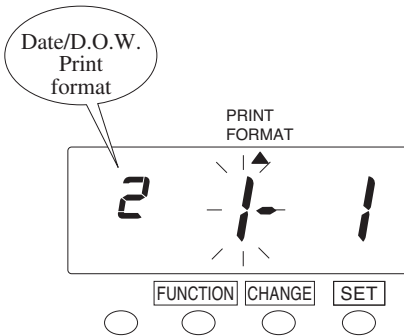

Set the "Date/D.O.W." print format.

	Order Option
1	Date
2	Day of the week

- 3 In this example, push the **CHANGE** button to set the left-side number at "2" and then push the **SET** button. At that moment, the flashing of the display will change to the middle number.

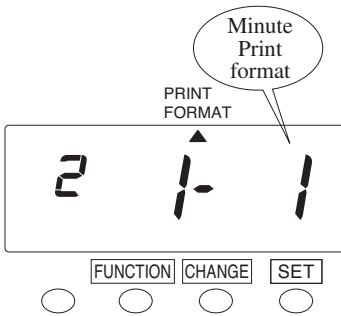
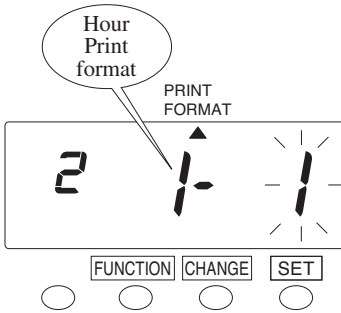

Set the "Hour" print format.

	Order Option
1	AM/PM
2	24 hour

- 4** In this case, push the **CHANGE** button to set at "1" and then push the **SET** button. At that moment, the flashing of the display will change to the right-side number.

Set the "Minute" print format for totals only.

Punch times only show in minutes.

	Order Option
1	Regular minutes
2	Hundredths

- 5** In this case, push the **CHANGE** button to set at "1" and then push the **SET** button.
- 6** Push the **SET** button once again.

You have completed this setting. Go to the next setting listing in "Default Settings" on page 7 to continue with the setup.

Setting the Rounding

For Rounding, there are two options: **Hourly Rounding** and **Punch Time Rounding**.

Using Hourly Rounding, the recorder calculates the hours from time IN punch and time OUT punch, and rounds that result with the "Rounding Unit". The fractions that occur after rounding will be omitted by breakpoint.

Using Punch Time Rounding, the recorder rounds both the time IN punch and the time OUT punch, and then it calculates the hours from the time IN punch and the time OUT punch. When rounding the time IN punch, it will raise the fractions that occur and, for the rounding of the time OUT punch, it will omit the fractions by breakpoint.

Special Note Regarding "Punch Rounding"

When calculating employee hours, it is a common business practice to round to the nearest quarter or tenth of an hour. The EP800 supports both punch and totals rounding. However, it is important that you understand how punch rounding works before setting the EP800. Rounding only affects calculations, and actual punch times are always printed on the time card.

First you must determine the proper rounding unit. If you want to round to the **tenth of an hour**, then the interval is **6 minutes**. If you want to round punches to the quarter hour, then the interval is **15 minutes**.

The following Rounding Units are available within the EP800:

1. None (exact minute)
2. 6 minutes with a 3 minute breakpoint (tenth of an hour)
3. 15 minutes with a 3 minute breakpoint (quarter hour)
4. 15 minutes with a 7 minute breakpoint (quarter hour)

The following is an example of 15 minute rounding with a 7 minute breakpoint.

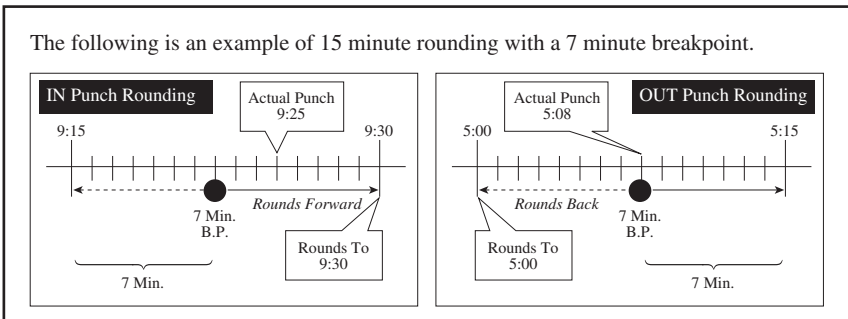

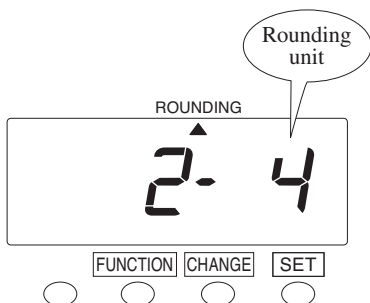
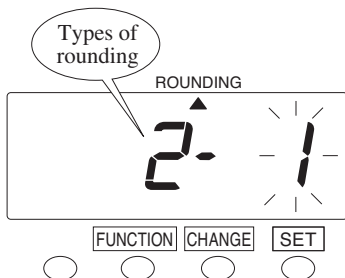
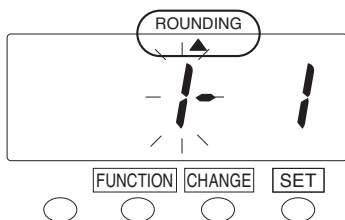

- 1 Push the **FUNCTION** button for 5 seconds.
- 2 Push the **FUNCTION** button until the position of the "▲" is under the "ROUNDING" mark.

Set the "Types of rounding".

	Order Option
1	Hours (Hourly rounding)
2	Punch (Punch time rounding)

- 3 In the case of the example, push the **CHANGE** button to set the left-side number at "2" and then push the **SET** button. At that moment, the flashing of the display will change to the right-side number.

Set the "Rounding unit".

	Order Option
1	None
2	6 minute 3 breakpoint
3	15 minute 3 breakpoint
4	15 minute 7 breakpoint

- 4 In this case, push the **CHANGE** button to set at "4" and then push the **SET** button.
- 5 Push the **SET** button once again.

You have completed this setting. Go to the next setting listing in "Default Settings" on page 7 to continue with the setup.

Setting the Auto Break Deduction

The EP800 will deduct the break amount **after** totaling the hours **and** if the total hours are equal to or greater than the "Elapsed Time" setting.

Break times can be automatically deducted from totals using the "Auto Break Deduction" feature. You must set a base working elapsed time and break duration. Once total working hours reaches to Elapsed Time, Break Duration will be deducted from the total working hours.

Example: Auto Break Deduction setting
 Elapsed time ... 8 hours Break duration ... 60 min.

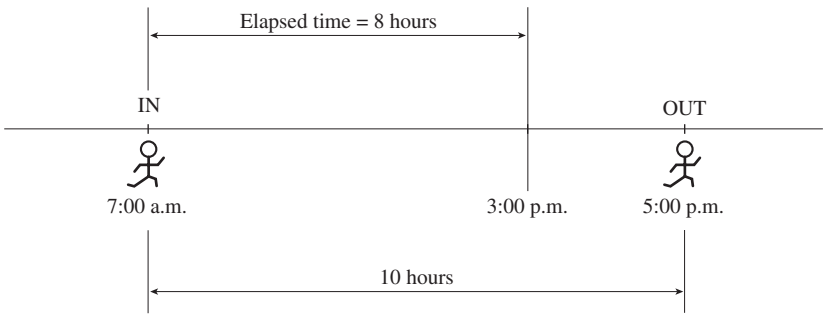

Auto Break Duration setting	Print example		
	IN	OUT	TOTAL
Yes	7:00 A	5:00 P	9:00 ^(B)
No	7:00 A	5:00 P	10:00

"B" is to indicate that Auto Break Deduction is valid.

For example, if you have a 30 minute lunch break that you want to deduct and the lunch break starts 4 hours into work day, set elapsed time to 4:30 and set Break duration to 30. Thus, 30 minutes would be deducted from any punch made 4 hours, 30 minutes in the work period.

Setting the Auto Break Deduction (continued)

Example

Elapsed time ----- 8 hours Break duration ----- 60 min.

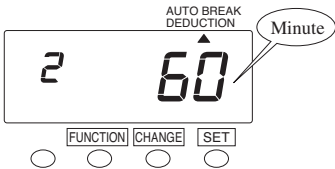
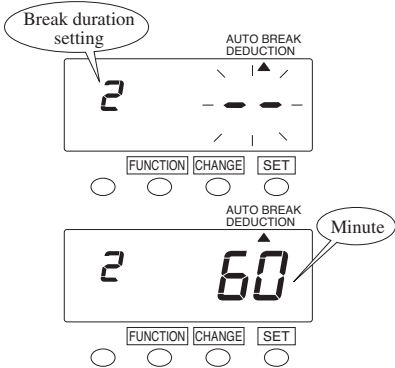
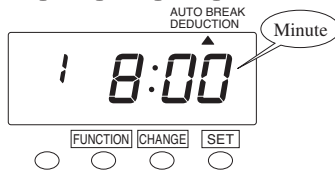
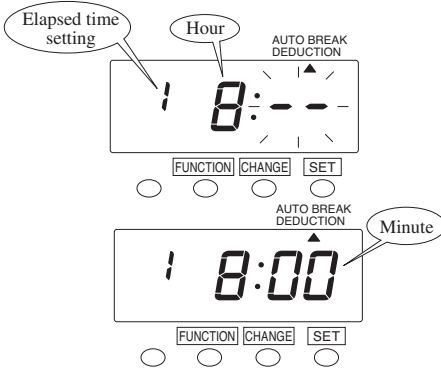
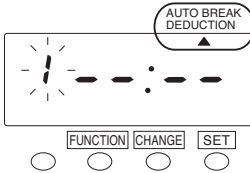

	Order Option
1	Elapsed time
2	Break duration

- 1 Push the **FUNCTION** button for 5 seconds.
- 2 Push the **FUNCTION** button and position the "▲" under the "AUTO BREAK DEDUCTION" mark.

Set the "Elapsed time".

- 3 Push the **SET** button. At that moment, the flashing changes to "Hour". In the case of the example, push the **CHANGE** button to set at "8" and then push the **SET** button. At that moment, the flashing of the display will change from "Hour" to "Minute".

- 4 In this case, push the **CHANGE** button to set at "00". And then push the **SET** button.

Set the "Break duration".

- 5 Push the **CHANGE** button twice to set the left-side number at "2" and then push the **SET** button. At that moment, the flashing of the display will change to "Minute".

- 6 In this case, push the **CHANGE** button to set at "60". And then push the **SET** button.

Range of value: 1 - 90 min.

- 7 Push the **SET** button once again.

You have completed this setting. Go to the next setting listing in "Default Settings" on page 7 to continue with the setup.

Setting the Max In

In order to properly identify missed punches, the recorder has Max In Value that is used to pair punches for calculations. If the next punch following an IN punch exceeds the Max In Value (i.e., 13 hrs.), then it is assumed that the employee forgot to punch OUT, and that punch is actually printed as the next IN punch. The employee can override this and force the recorder to make OUT punch by pressing the OUT button before inserting the time card. For this override OUT punch to work, the Button Function must be enabled. (See "Setting the Button Function".)

If the "Max In Override" is set to 'No', then the clock will not assume that a punch was missed, and the clock will calculate as punched.

Example: Max In Override ----- No Max In Value ----- 17 hours

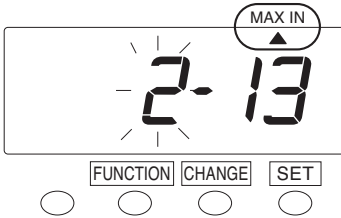

- 1 Push the **FUNCTION** button for 5 seconds.
- 2 Push the **FUNCTION** button and position the "▲" under the "MAX IN" mark.

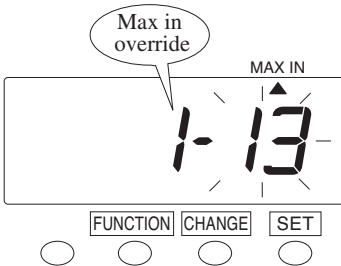

Set the "Max In Override".

	Order Option
1	No
2	Yes

- 3 In the case of the example, push the **CHANGE** button to set the left-side number at "1" and then push the **SET** button. At that moment, the flashing of the display will change to the right-side number.

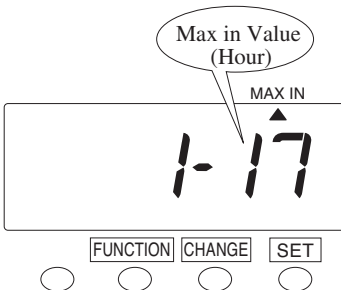

Set the "Max In Value".

- 4 In this case, push the **CHANGE** button to set at "17". And then push the **SET** button.

Range of value: 1 - 24 hours

- 5 Push the **SET** button once again.

You have completed this setting. Go to the next setting listing in "Default Settings" on page 7 to continue with the setup.

Setting the Button Function (In/Out)

You can select one of three functions for the buttons.

Required

You must push the "IN" or "OUT" button immediately prior to inserting the time card. If not, the card will be ejected and an error sign will appear.

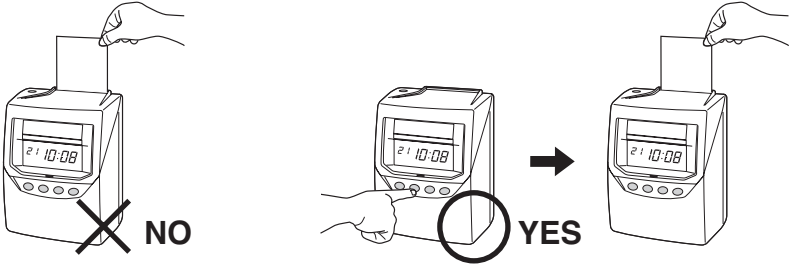

Optional

When the time card is inserted, the recorder will judge the last imprint and automatically switch the "IN" and "OUT". You may also manually switch the column position of the imprint by pushing the button.

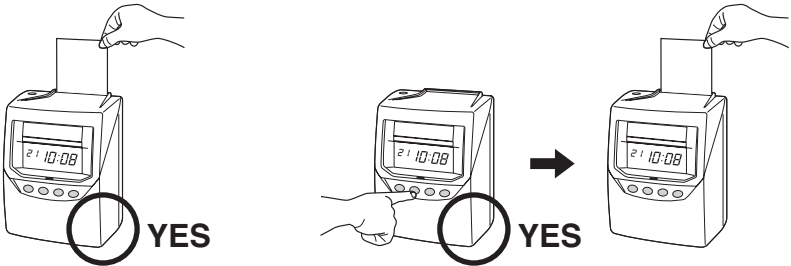

Disabled

When the time card is inserted, the recorder will judge the last imprint and automatically switch the "IN" and "OUT". The buttons are disabled for normal operation.

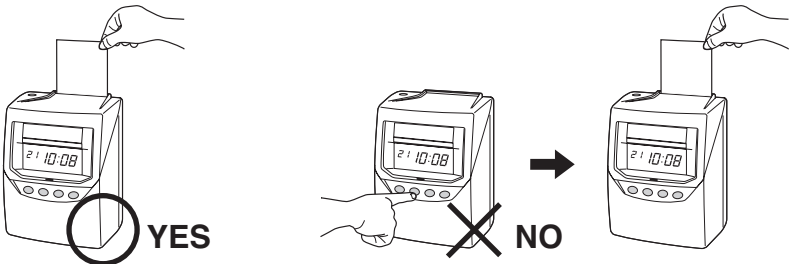

Setting the Button Function (In/Out) (continued)

The functions for the buttons on the front of the recorder can be set. There are three options; **Required, Optional, Disabled**.

The default setting is **Optional**.

Example

Select "Required" for the button.

	Order Option
1	Required
2	Optional
3	Disabled

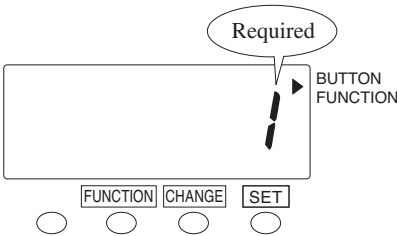
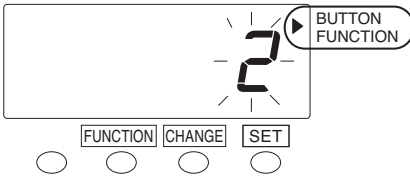

- 1 Push the **FUNCTION** button for 5 seconds.
- 2 Push the **FUNCTION** button and position the "▲" next to the "BUTTON FUNCTION" mark.
- 3 In the case of the example, push the **CHANGE** button to set at "1". And then push the **SET** button.
- 4 Push the **SET** button once again.

You have completed this setting. Go to the next setting listing in "Default Settings" on page 7 to continue with the setup.

Setting the Daylight Savings Time

Automatic DST correction

By default, the daylight savings time is already set to start on the second Sunday of March and to end on the first Sunday of November. The time clock automatically updates the settings every year. No further manual setting is necessary.

If you are located in an area that does not observe Daylight Savings Time, you can also disable DST function by changing the display of "Month" of the starting setting to "--". (Refer to "Deleting the Daylight Savings Time settings".)

If the above pre-determined DST dates should change then use this function to change the DST clock dates. Please refer to following example.

Example		
Today (present day)	Wednesday, January 6, 2010	
Starting date of Daylight Savings Time	Sunday, March 14, 2010	The second Sunday of March
Ending date of Daylight Savings Time	Sunday, November 7, 2010	The first Sunday of November

1 Push the **FUNCTION** button for 5 seconds.

2 Push the **FUNCTION** button and position the "▲" next to the "DAYLIGHT SAVINGS" mark.

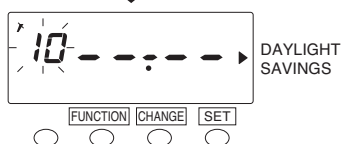
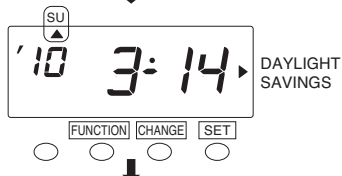
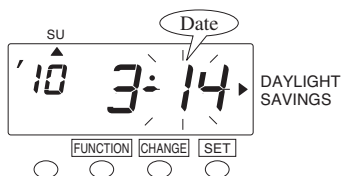
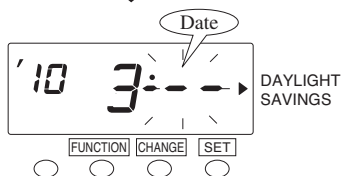
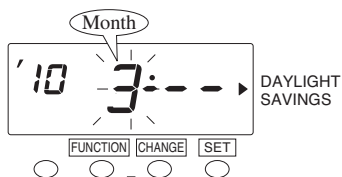
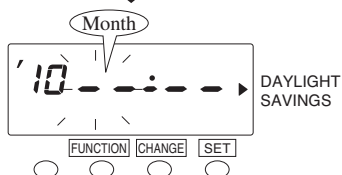
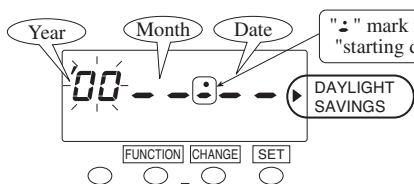

Set the "starting date".

3 In the case of the example, push the **CHANGE** button to set at "10" and push the **SET** button.

At that moment, the flashing changes from "Year" to "Month".

4 Push the **CHANGE** button to set at "3" and push the **SET** button.

At that moment, the flashing changes from "Month" to "Date".

5 Push the **CHANGE** button to set at "14" and push the **SET** button.

At that moment, "starting date" of the display changes from flashing to steady and the "▲" mark is displayed under "SU". Wait a few seconds, then start on Step 6.

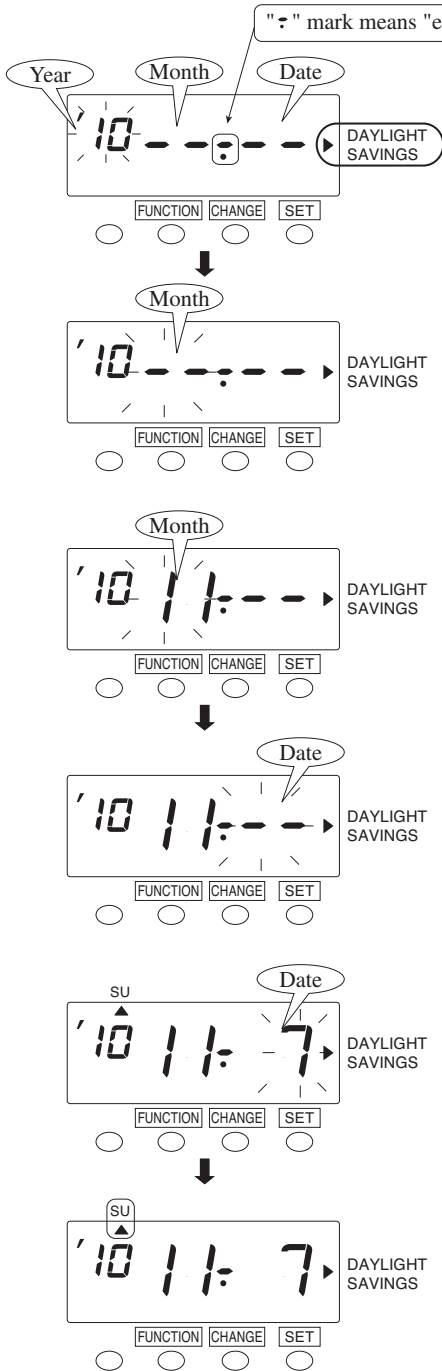

Set the "ending date".

6 Next, push the **SET** button. At that moment, the flashing changes "Year" to "Month".

7 Push the **CHANGE** button to set at "11" and push the **SET** button. At that moment, the flashing changes from "Month" to "Date".

8 Push the **CHANGE** button to set at "7" and push the **SET** button. At that moment, "ending date" of the display changes from flashing to steady and the "▲" mark is displayed under "SU".

9 Push the **SET** button once again.

Deleting the Daylight Savings Time settings

- 1 Push the **FUNCTION** button for 5 seconds.
- 2 Push the **FUNCTION** button and position the "▲" next to the "DAYLIGHT SAVINGS" mark.

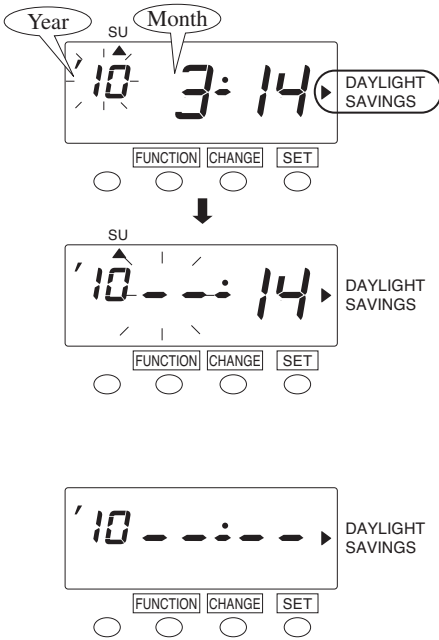

- 3 Push the **SET** button and the flashing changes from "Year" to "Month".
Next, push the **CHANGE** button until the "Month" changes to two dashes, or "--". The two dashes are the next setting after '12'.

- 4 Push the **SET** button twice. This cancels the daylight saving time settings.

- 5 Push the **SET** button once again.

You have completed this setting. Go to the next setting listing in "Default Settings" on page 7 to continue with the setup.

Setting the Print Language

English, Spanish, or French can be selected to print "Month" and "the days of the week".

The default language is English.

The print language can be selected from the following three options.

Options	Print Example: Thursday 3:30 p.m.
1. English	TH 3 : 30P
2. Spanish	JU 3 : 30P
3. French	JE 3 : 30P

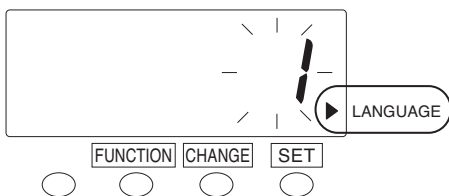

1 Push the **FUNCTION** button for 5 seconds.

2 Push the **FUNCTION** button to position the "▲" next to the "LANGUAGE" mark.

Push the **CHANGE** button to set the number at the desired print language. For example, set 3 if French is desired.

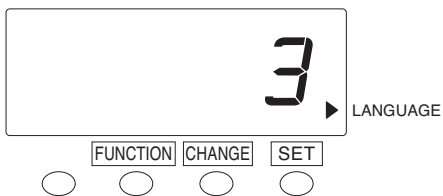

3 Push the **SET** button. At that moment, the display will change from flashing to steady.

4 Push the **SET** button once again.

You have completed this setting. Go to the next setting listing in "Default Settings" on page 7 to continue with the setup.

4. OPERATIONS & FUNCTIONS

Once the AC line cord is plugged into the outlet, the recorder can be used immediately. The current time (EST) and date are preset. The time card is automatically pulled in, printed, and then ejected.



Do not let any metallic object get into the slot including paper clips. Do not forcefully push in a card, either. These may cause the unit to malfunction.

- A maximum of 100 cards can be automatically registered.
- When a new card is inserted, the card will automatically be registered, and will print the "IN" print on the first line. The month will be printed on the first line and also on the line when the month and printing line change.
- You can print "IN" and "OUT" as many times as you want per day. The printing line, will slide one line down each time you insert the card for "IN" print.
- When the card that you are using becomes full, the clock will show "End" on the display. When the "End" appears, you can use the "Card reassign" mode to transfer the card and have a new card take over from the old one.

Refer to "Card reassign" on page 37.

- When you want to reset the card (clear the accumulated totals) manually, you can use the "Card reset" mode to reset a single card or use the "All cards reset" mode to reset all the cards in memory. It is not necessary to routinely reset cards manually, since the clock does this automatically each pay period (unless using Job Cost Mode).

Refer to "Card reset" on page 39 and "All cards reset" on page 38.

RADIO SIGNAL RECEPTION

About Radio Signal Reception

The Model EP800 is programmed to see the WWVB radio signal everyday. Initially the time recorder will search for a signal immediately after you set the time zone. Once the clock has initially set, it will search for the signal every few hours per day to maintain accuracy. The WWVB signal is the strongest early in the morning, when there is the least amount of interference from other sources.

There are some environments and weather conditions that may influence the reception of the AM radio signal. Just as with an AM radio, the Model EP800 can be positioned for optimal reception. For instance, it is best to position the clock away from metal studs and toward the direction of the tower in Colorado. Since this time recorder contains a highly accurate quartz timer, it will function with a very high level of accuracy between signal receptions. The Model EP800 will operate as a normal electronic time recorder without having to receive the signal. Since it also operates as a highly accurate (+/- 15 seconds per month) quartz time clock, it will function properly while outside the reception area or if it can not receive the WWVB signal.

Verifying the Time

The best way to verify the correct time is to call the NIST at (303) 499-7111 (long distance charges may apply). Any other sources, including the time number in your local phone book, the Internet, cell phones, and Cable TV receivers may be off by several seconds.

Signal Reception Indicator

FLASHING: Unit is receiving the atomic radio signal.

ON: Unit successfully received the atomic radio signal.

OFF: Unit was unable to receive the radio signal.
(See "Troubleshooting" section.)



Reception indication

Resetting Settings

To return all settings to their factory defaults.

Please note that all settings will be deleted and will revert to the factory defaults when the reset switch is pushed. To make new settings, please refer to "Default and Advanced Settings" (pages 7-8).

Stored cards are also deleted from memory.

If you want to just reset all cards, refer to "All cards reset" on page 38.

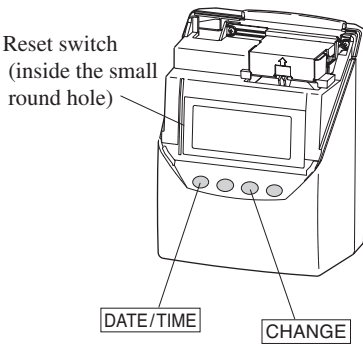

1 Push the reset switch with a pointed implement while pushing the **DATE/TIME** and **CHANGE** button.

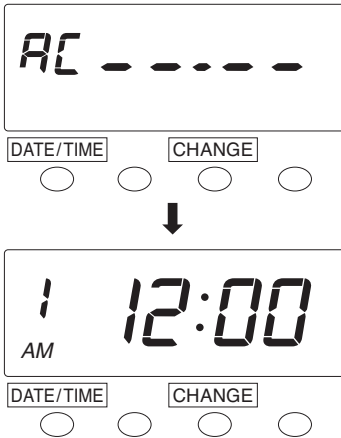

2 At that moment, the display will change to AC " - - - - - ". And after a few seconds, the display changes to date & time "1 12:00 a.m.".

Resetting Cards In Job Cost Mode

You can reset the card without removing the cover when the time recorder is used under the following condition.

- The Job Cost Mode and also the card "Reset" setting is YES.

Refer to "Job Cost Mode" in "Setting the Mode".

In order to reset the card, you must push the right-side button (Reset button) and then insert the card.

After printing "RESET", the card shall be ejected.

Once you push the button, the unit starts beeping. Make sure to insert the card while it beeps.

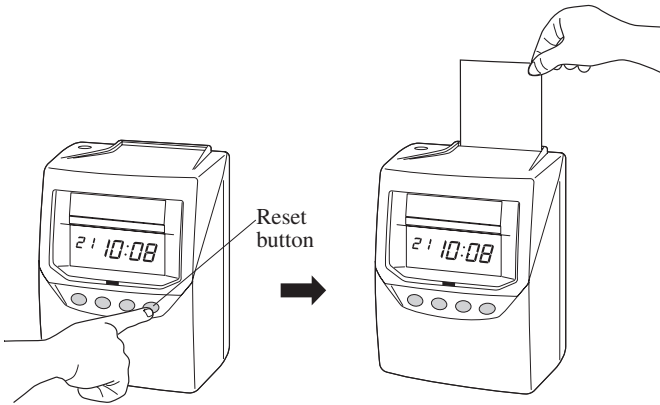

Note: If the last punch was IN, you must insert the card twice.

A fully used card can also be reset by this operation, but without printing the word "RESET".

Card reassign

When the card that you are using becomes full (Max 64 punches), it will show "End" on the display and the buzzer will sound. When the "End" appears, you can use the "Card reassign" mode to transfer the card and have a new card take over from the old one.

In this function, it will be useful:

- when the card has become full before reaching the "Pay Period". [In Payroll Mode]
- when the card that is lost or damaged.

You can transfer the old card to a new one with the same number or the one which is not used in the current pay period. If you are already using all time cards from No. 1 to 100, you can transfer the card only to the new one with the same card number. If you prefer to use another time card with a different number, you must reset the corresponding card first.

Example

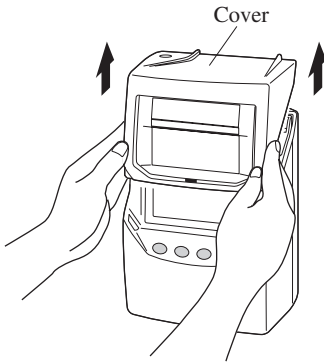
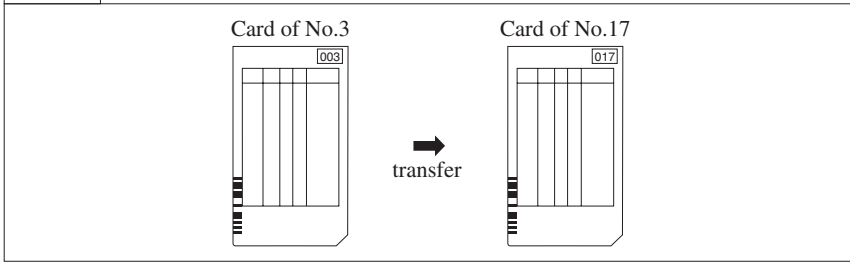

1 Remove the cover.

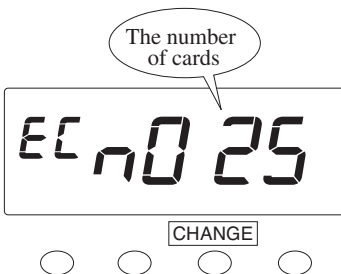

2 Push the **CHANGE** button for 5 seconds.

When you have a card that you are using, the number of cards that you are using will be shown on the display. If there are no cards used at the present state, it will show "n000" and will end the mode.

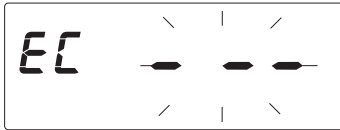

- 3 After the numbers of cards are shown, in the example, insert the card "003" or push the **CHANGE** button to show the card number "003" and then push the **SET** button.

- 4 Next insert the card "017" or push the **CHANGE** button to pick a new card number "017" and then push the **SET** button.
When the card number is changed, this mode will finish.

All cards reset

You want to reset all cards manually.....

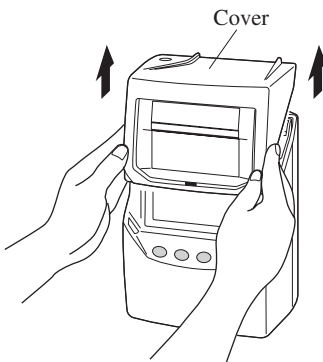

- 1 Remove the cover.

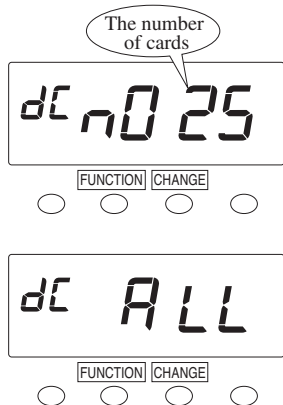

- 2 Push the **FUNCTION** and **CHANGE** button for 5 seconds. The number of cards that you are using will be shown on the display.
- 3 Push the **CHANGE** button to show "ALL" and then push the **SET** button.
- 4 Push the **SET** button one more time.

Card reset

If you want to reset the card manually before the end of pay period, you can use the "Card reset" mode.

Example: The number of the card you want to reset is "003".

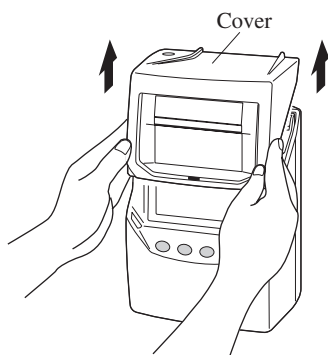

- 1 Remove the cover.

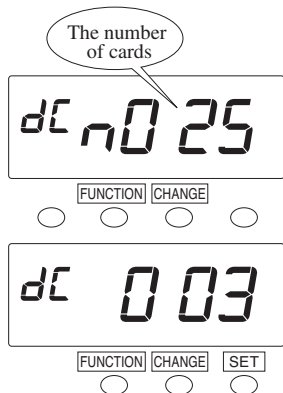

- 2 Push the **FUNCTION** and **CHANGE** button for 5 seconds. The number of cards that you are using will be shown on the display.
- 3 In the example, insert the card "003" or push the **CHANGE** button to show the card number "003" and then push the **SET** button.
- 4 Push the **SET** button.

5. PRINT EXAMPLE

No. 20
 Name SAM WHITE
 Period JULY 7
 Hours _____ Rate _____ Amount _____

START	STOP	WORKED	ACCUMULATED	TASK
IN	OUT	HOURS	TOTAL	COMMENTS
J 9:02	~16:52	7:45	7:45	
~ 9:01	~17:02	7:30B	15:15	
* 9:01	~16:31	7:30	22:45	
+ 9:00	+16:28	7:30	30:15	
~ 9:01	~16:32	7:30	37:45	
* 9:03	~16:29	7:30	45:15	
~ 9:00	~16:31	7:30	52:45	

Month _____ Date _____ Time _____
 B = Automatic Break Deduction
 Signature Sam White
 © SIMPLEX TIME RECORDER CO. 1-800-626-6206 www.simplexgimellstore.com 1950-4301

Note:

- "S" is to indicate totals across daylight savings adjustment.
- "*" is to indicate the following meanings.
 - (1) Rounded time result comes to 0:00
 - (2) Daylight savings adjustment was done in the period of calculation.
- "B" is to indicate accumulation result includes auto break deduction.

6. INSTALLING BATTERY (Optional)

(P/N: 1410-5020)

Follow the steps below to install a battery (optional) so that the clock would be operational during a power failure.

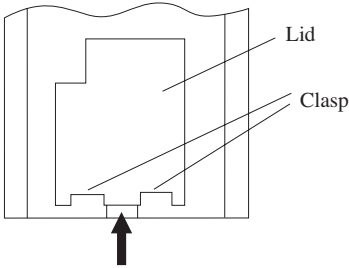

- 1 Remove the lid of the battery compartment on the back of the unit by pushing up the center of the lid, and then release it from the two clasps.

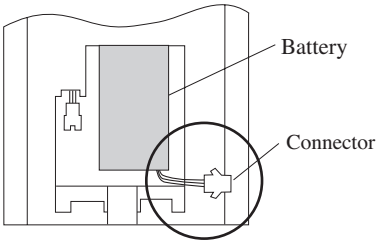

- 2 Position the battery as shown in the figure on the left .
* The connector cord should be on the right side, as shown in the figure.

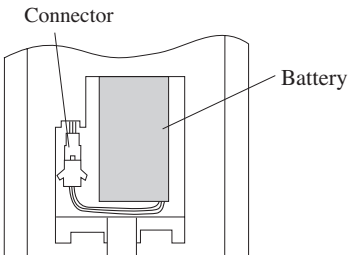

- 3 Connect the connector. Tuck away the connector cord into the open space in the compartment.

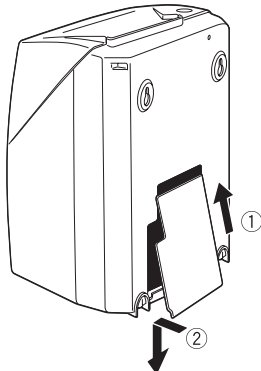

- 4 Insert the lid into the slot as shown on the left. Keep pressing it down until it hooks to the clasp.
* Make sure the cord is not caught when closing the lid.

7. TROUBLESHOOTING

Error No. Causes and Actions

No.	Error causes	Action
E-00	CPU error	Contact SimplexGrinnell.
E-01	The remaining life of lithium battery for memory back-up is short.	Return clock to SimplexGrinnell for service.
E-03	Card inserted on wrong side.	The front of the card must be completely filled in before using the back of the card.
E-05	The card is not pulled in properly.	Make sure that another time card or another item is not jamming in the time recorder. Try inserting the time card again.
E-15	Card sensor error	Make sure that another time card is not jamming in the time recorder and the ribbon cassette is correctly inserted in place.
E-30	The printer motor or the sensor is not normal.	After making sure of the above, close the cover.
E-37	The card forwarding motor or the sensor does not operate properly.	If the error number continues to be displayed, contact SimplexGrinnell.
E-38	The print head motor or the sensor for the printer head can not operate properly.	<ol style="list-style-type: none"> 1. Remove and re-insert the ribbon. 2. Move clock to a dust free location. 3. Send to SimplexGrinnell for cleaning and service.
E-49	Input the wrong settings.	Pay Period settings cannot be changed while cards are stored in memory. An All Cards Reset must be done before making changes to Print Format, Pay Period type, or Pay Period start date.
E-50	Can't use the time card.	<ol style="list-style-type: none"> 1. Make sure cards are form 1950-4301 and made by SimplexGrinnell. 2. Check to make sure the barcode area of the card is not smudged or damaged.
E-51	Calculation Error	Re-insert card after 1 minute has elapsed. Card cannot be inserted twice in the same minute.
E-52	Calculation Logic Error	Ensure current date is within pay period dates. May need to 'Reset Settings' if error continues to be displayed.
E-59	Can't use the time cards because of memory error.	Use the "Card Reset" function to reset the card. Make sure if you can print by inserting the time card with the same number.
End	When the card that you are using becomes full.	Use the "Card reassign" mode to transfer the card and have a new card take over for the old one.

* If the error number is still displayed after checking above points, contact SimplexGrinnell.







Troubleshooting Questions & Answers









Questions	Answers
What do I do if the clock does not operate?	Ensure the power cord is properly plugged into the AC outlet.
What do I do if the clock does not print?	Ensure the ribbon is installed properly.
What do I do if the time is exact to the minute but the hour is incorrect?	<ol style="list-style-type: none">1. Ensure the correct time zone is selected.2. Check the Daylight Savings Time setting.
What do I do when the cards are sticking in clock?	Remove paper clips or "sticky notes" from inside clock.
What do I do when the clock rejects the cards without printing?	<ol style="list-style-type: none">1. Make sure bar code on cards are not smudged.2. Removing anything that is blocking bar code sensor i.e. Sticky pads, from time cards.
What do I do if clock makes a strange noise and doesn't print correctly?	<ol style="list-style-type: none">1. Replace or reinstall ribbon.2. Check print head.3. Send to SimplexGrinnell or authorized dealer for cleaning and service.
What to do if print head is not moving at all? Will not accept cards.	Send to SimplexGrinnell or authorized dealer for service.
What to do if print head is moving but it prints very lightly or not at all?	<ol style="list-style-type: none">1. Make sure ribbon is installed properly.2. Install new ribbon.
What do I do if no WWVB signal has been received?	<ol style="list-style-type: none">1. Wait for the early morning hours to pass.2. Re-locate in area that is away from metal studs or close to western facing window.

Note: There are some environments and weather conditions that may influence the reception of the atomic clock radio signal. Since it also operates as a highly-accurate (+/- 15 seconds per month) quartz time clock, the EP800 will function properly while outside the reception area or if it can not receive the WWVB signal.

8. Warnings & Cautions

Please follow all the instructions to avoid possible danger to yourself or others and damage to the unit.

 Warning	
	Do not disassemble the unit. There is a high voltage present inside, possibly leading to an electric shock.
	Do not modify the unit. Modifications may cause a fire and/or electric shock.
	If any anomaly occurs, for example, heat or smoke is generated or an odor is emitted, unplug the unit immediately and contact your dealer for servicing. There is a danger that further use may cause a fire or electric shock.
	Do not use any voltage of the power source other than designated. Do not share a single outlet with another plug. These may lead to fire or shock hazards.
	Do not damage, break, or modify the power cord. Do not put a heavy object on, pull, or forcefully bend the cord, either. These may damage the cord, possibly resulting in a fire or electric shock.
	If foreign matter should get in the unit (including a piece of metal, water, or liquid), disconnect the plug from the outlet immediately and contact your dealer for servicing. There is a danger that further use may cause a fire or electric shock.

 Caution	
	Do not put a water-filled container or a metal object on top of the unit. If water is spilled or the metallic object slips inside, a fire or shock hazard may occur.
	Do not install the unit in a humid or dusty environment. It may cause a fire or electric shock.
	Do not place the unit near kitchen counter or humidifier. Oil, smoke, or steam generating from them may cause fire or shock hazards.
	Be careful not to contact the print head, as you may get hurt or burned.
	Do not insert or drop any other time card than specified into the slot. Such misuse may cause a fire or electric shock.
	If the unit should be dropped or the case be broken, unplug the unit and contact your dealer for servicing. Further use may lead to a fire or shock hazard.
	Lithium battery contains perchlorate material - special handling may apply. Please go to web site http://www.dtsc.ca.gov/hazardouswaste/perchlorate for information about proper methods of disposal.

Daily Care

For cleaning, turn the power off and wipe the case clean of dust and dirt with a dry cloth, etc.

9. SPECIFICATIONS

Clock accuracy	Monthly accuracy $\pm 15\text{s}$ (at ordinary temperature)
Calendar	Year up to 2099. Automatically adjusted to leap years, 31-day months and months with thirty or fewer days, and the days of the week.
Printing system	Dot matrix
Power failure compensation	Three years of cumulative power failure hours after the date of shipment
Print at power failure	Optional battery, 100-time printing or 24 hours (P/N:1410-5020)
Memory capacity	100 employee capacity
Operating environment	Temperature: -5° to $+45^{\circ}\text{C}$: $+23^{\circ}$ to $+113^{\circ}\text{F}$ Humidity: 20 to 80%RH, no condensation The unit operates normally at temperatures of 5°C or below, but the print density, reaction of the liquid crystal display, and the number of prints at power failure are inferior to those at normal temperature operation.
Dimensions	6.3" (w) x 8.07" (h) x 5.04" (d) 160 (w) x 205 (h) x 128 (d) mm
Weight	Approx. 3.5lbs. (1.6kg)
Rating	120VAC 50/60Hz 0.3A

- Optional battery (not included) for 100% printer operation during power failures is available. Order part no. 1410-5020
- Ni-MH Battery rated 8.4V, 600mAh. Caution: Replace only with the same type of battery specified by the manufacturer.
- Place the time recorder at the position close to the wall outlet so that it is easily accessible to disconnect.
- Lithium battery contains perchlorate material - special handling may apply.
Please go to the web site <http://www.dtsc.ca.gov/hazardouswaste/perchlorate> for information about proper methods of disposal.

Warranty

Subject to the limitations set forth below, SimplexGrinnell warrants that the Products shall be free from defects in material and workmanship under normal use for the period of 90 days commencing on the date of 1) first beneficial use of all or any part of Product if installed by SimplexGrinnell or 2) Product shipment, whichever is earlier.

SimplexGrinnell's sole liability, and purchaser's sole remedy, under this Warranty, shall be limited to the repair or replacement of any Product, or part thereof, which SimplexGrinnell determines to be defective, at SimplexGrinnell's sole option and subject to the availability of service personnel and parts, as determined by SimplexGrinnell. Warranty service will be performed between the hours of 8:00 a.m. to 5:00 p.m. local time, Monday through Friday exclusive of SimplexGrinnell's holidays. Warranty service requested to be performed at other than during SimplexGrinnell's normal work hours shall be chargeable to SimplexGrinnell's standard overtime and travel rates. All repairs that are or may become necessary under the warranty provisions of this Agreement shall be performed only by an authorized SimplexGrinnell representative. Purchaser agrees to provide full and free access to such authorized SimplexGrinnell representative to make such repairs. Any repairs, adjustments, or interconnections performed by the purchaser or anyone other than an authorized SimplexGrinnell representative shall void all warranties. This warranty extends to the original purchase only and is non-transferrable.

THIS WARRANTY DOES NOT APPLY TO ANY PRODUCT THAT HAS BEEN SUBJECT TO ABUSE, MISHANDLING, OR IMPROPER USE AS DETERMINED BY SIMPLEXGRINNELL AND IS IN LIEU OF ALL OTHER WARRANTIES, EXPRESSED OR IMPLIED, INCLUDING ANY IMPLIED WARRANTY OF MERCHANTABILITY OR FITNESS FOR A PARTICULAR PURPOSE. This Warranty expressly excludes program and schedule changes, failures due to external causes, including but not limited to electrical surges, lightening, failure of electrical power, air conditioning or humidity control, damaging foreign substances, transportation, construction dust or debris, user programming errors, electrical work external to the equipment supplied by SimplexGrinnell, maintenance of accessories, alterations, attachments or other devices not furnished by SimplexGrinnell, ribbon replacement (other than defects), batteries, devices designed to fail in protecting a system such as, but not limited to, fuses and circuit breakers or any other causes other than manufacturing defect. SimplexGrinnell makes no warranty relating to or arising out of a claim or assertion that any Product infringes or violates any patent, copyright, or other proprietary right of any third party.

LIMITATION OF LIABILITY: SIMPLEXGRINNELL SHALL NOT BE LIABLE FOR ANY INDIRECT, INCIDENTAL, ECONOMIC, OR CONSEQUENTIAL LOSS OR DAMAGE TO THE PURCHASER OR USER OF THIS PRODUCT ARISING OUT OF, AMONG OTHER THINGS, THE OPERATION OR FAILURE OF THE PRODUCT TO OPERATE, THIS AGREEMENT, THE INSTALLATION, USE, DESIGN OR FUNCTION OF ANY SIMPLEXGRINNELL PRODUCT.



Corporate Sales and Marketing: 50 Technology Drive, Westminister, MA 01441-0001, Toll Free: 1-888-777-9237
Canada: 2400 Skymark Avenue, Mississauga, Ontario L4W 5K5 Telephone 1-800-565-5400

© 2011 SimplexGrinnell LP. All rights reserved. Printed in the U.S.A.